

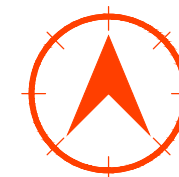

**PLAN DE INCADRARE IN ZONA
UAT
CORDUN
JUD. NEAMT
SATE:
PILDESTI, SIMIONESTI, CORDUN
DESCRIEREA LUCRARILOR CIVILE:**



Prin prezentul proiect se propune amplasarea aeriana a unei retele de fibra optica, tip FTTH, pe stalpi de beton existenti, proprietate Delgaz Grid, pe stalpi de lemn existenti, proprietate TELEKOM si pe stalpi de composit proiectati, proprietate Orange, precum si construirea unei canalizatii subterane in zona drumului judetean DJ 207B, precum si in zona strazilor si drumurilor satesti din cadrul UAT CORDUN, SATELE CORDUN, SIMIONESTI SI PILDESTI, JUD. NEAMT.

Cablul de fibra optica va fi pozat pe stalpii existenti de distributie a energiei electrice apartinand DELGAZ GRID, amplasati pe domeniul stradal al localitatii Cordun.

Se vor respecta conditiile prevazute in avizul favorabil nr. 36/2.04.2021 eliberat de DELGAZ GRID in urma caruia s-a intocmit studiul de coexistenta privind amplasarea cablului de fibra optica pe stalpi de beton existenti studiati.

DETALII RESEA TELECOMUNICATII (LUNGIMI):

RESEA FIBRA OPTICA	UM: [m]
LUNGIME TOTALA RESEA DE TELECOMUNICATII	48004
din care:	
RESEA FIBRA OPTICA AERIANA PROIECTATA	47858
RESEA FIBRA OPTICA SUBTERANA PROIECTATA	146

LEGENDA

- RESEA FO AERIANA PROPUSA IN ZONA UAT
- RESEA FO AERIANA PROPUSA IN ZONA DJ
- RESEA FO SUBTERANA PROPUSA
- RESEA FO EXISTENTA
- LIMITA INTRAVILAN / EXTRAVILAN
- LIMITA UAT

Verificator / Expert	NUME	SEMNAURA	CERINTA	REFERAT/EXPERTIZA NR./DATA
NR. V.566	ING ROTARESCU A. IOAN		A1, A2	
PROIECTANT:				PROIECT NR.:
S.C. HD PROIECTIS S.R.L. Sediul social: Bld. Carol I, Nr.4, Cladirea Habitat Project, Corp A, Etaj 2, Cam. 205-206, IASI J22/1230/2016 - RO36085083				ORANGE ROMANIA S.A. B-dul Lascar Catargiu, nr. 47-53, Europe House, sector 1, Bucuresti CUI: 9010105, J40/10178/1996
FORMAT PLANSA: 420 x 297 mm				TITLU PROIECT:
				INSTALARE TRASEU FIBRA OPTICA SUBTERAN SI AERIAN (RESEA FTTH) PE STALPII DELGAZ GRID S.A. SI NOI PROIECTATI, IN COMUNA CORDUN, JUDEUL NEAMT
SPECIFICATIE	NUME	SEMNAURA	SCARA:	Faza:
SEF PROIECT	ING. PRISACARU ANDREI		1:10000	D.T.A.C. + P.TH.+D.E.
PROIECTAT	ING. ALUCULESEI C.		DATA:	PLANSA NR.:
VERIFICAT	ING. CHIRILA IONUT		12.2021	T0
DESENAT	ARH. LORIN MARTINIUC			



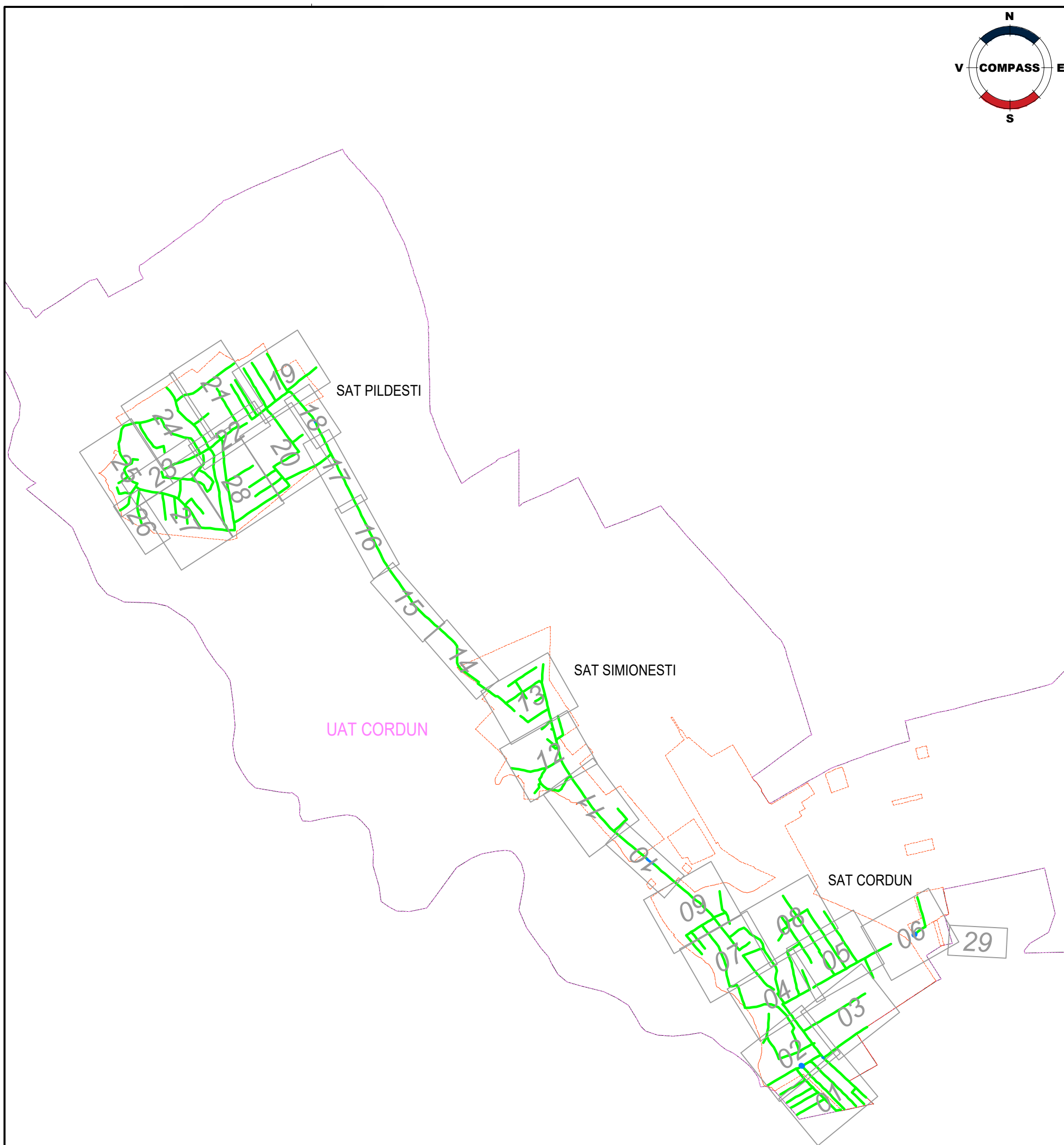
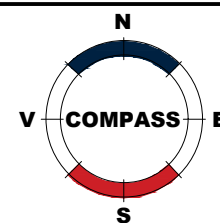

NOTA:

Prin prezentul proiect se propune amplasarea aeriana a unei retele de fibra optica, tip FTTH, pe stalpi de beton existenti, proprietate Delgaz Grid, pe stalpi de lemn existenti, proprietate TELEKOM si pe stalpi de composit proiectati, proprietate Orange, precum si construirea unei canalizatii subterane in zona drumului judetean DJ 207B, precum si in zona strazilor si drumurilor satesti din cadrul UAT CORDUN, SATELE CORDUN, SIMIONESTI SI PILDESTI, JUD. NEAMT.



Cablul de fibra optica va fi pozat pe stalpii existenti de distributie a energiei electrice apartinand DELGAZ GRID, amplasati pe domeniul stradal al localitatii Cordun.

Se vor respecta conditiile prevazute in avizul favorabil nr. 36/2.04.2021 eliberat de DELGAZ GRID in urma caruia s-a intocmit studiul de coexistenta privind amplasarea cablului de fibra optica pe stalpii de beton existenti studiat.

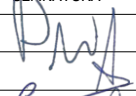

DETALII RESEA TELECOMUNICATII:

LUNGIME RESEA DE TELECOMUNICATII: 48004 m, din care:
AERIAN: 47858 m; SUBTERAN: 146 m
ZONA DJ 207B: 5621 m din care: AERIAN : 5530 m; SUBTERAN : 91 m
ZONA UAT: 42383 m, din care: AERIAN: 42328 m; SUBTERAN : 55 m
TOTAL STALPI UTILIZATI: 1173 buc din care :
STALPI EXISTENTI: 1045 buc; STALPI PROIECTATI : 114 buc
ZONA DJ 207B: 144 buc, din care: EXISTENTI: 141 buc; PROIECTATI: 3 buc
ZONA UAT: 1029 buc, din care: EXISTENTI: 918 buc; PROIECTATI: 111 buc.

Verificator / Expert	NUME	SEMNAURA	CERINTA	REFERAT/EXPERTIZA NR./DATA		
NR. V.566	ING ROTARESCU A. IOAN		A1, A2			
PROIECTANT:			S.C. HD PROIECTIS S.R.L. Sediul social: Bld. Carol I, Nr.4, Cladirea Habitat Proiect, Corp A, Etaj 2, Cam. 205-206, IASI J22/1230/2016 - RO36085083		 ORANGE ROMANIA S.A. B-dul Lascar Catargiu, nr. 47-53, Europe House, sector 1, Bucuresti CUI: 9010105, J40/10178/1996	PROIECT NR.: 93 2021
FORMAT PLANSA: 297 x 420 mm			TITLU PROIECT: INSTALARE TRASEU FIBRA OPTICA SUBTERAN SI AERIAN (RESEA FTTH) PE STALPII DELGAZ GRID S.A. SI NOI PROIECTATI, IN COMUNA CORDUN, JUDEUL NEAMT		Faza: D.T.A.C. + P.TH.+D.E.	
SPECIFICATIE	NUME	SEMNAURA	SCARA:	DENUMIRE PLANSA: SCHEMA RACORDARE PLANSE UAT CORDUN, SAT CORDUN, SAT SIMIONESTI, SAT PILDESTI JUD. NEAMT		
SEF PROIECT	ING. PRISACARU ANDREI		-			
PROIECTAT	ING. ALUCULESEI C.		DATA:			
VERIFICAT	ING. CHIRILA IONUT		12.2021			
DESENAT	ARH. LORIN MARTINIUC			PLANSA NR.:	SRP DTAC	

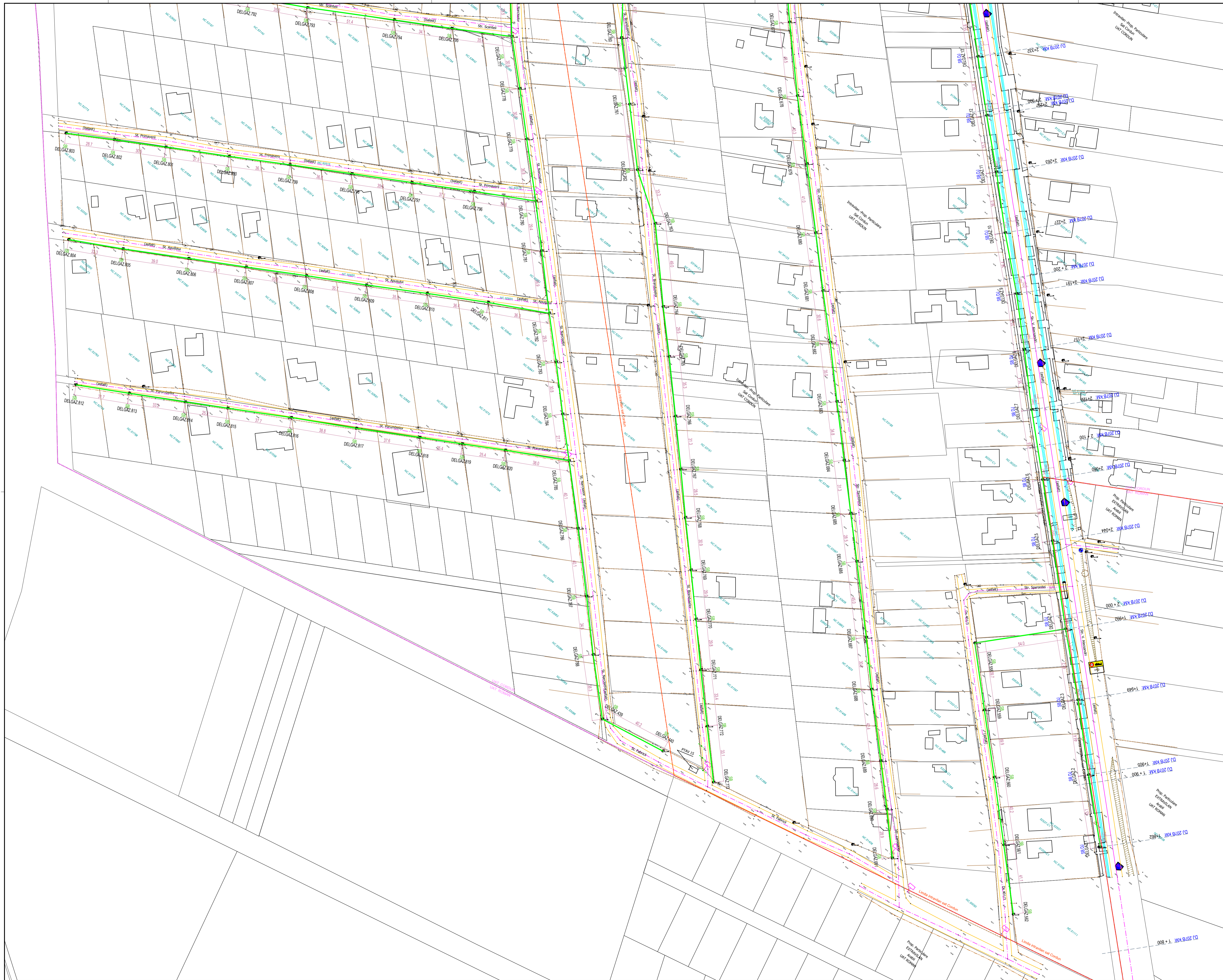

LEGENDA

LS	LUNGIME SANT 0.4 x 1.2 m
LT	LATIME TUB
140mm	NUMAR x DIAMETRU MONOTUB HOPE PROIECTAT
---	RETEA FO EXISTENTA MONTATA SUBTERAN
---	CANALIZATIE FO SUBTERANA EXISTENTA
---	CAMERETA EXISTENTA
---	INDICATIV NR. CAMERETA EXISTENTA
---	RETEA FO AERIANA PROIECTATA
---	RETEA FO MONTATA SUBTERAN PROIECTATA
DELGAZ 1	INDICATIV NR. STALP BETON EXISTENT IN ZONA DJ SI UAT
TELEKOM 1	INDICATIV NR. STALP LEMN EXISTENT IN ZONA DJ SI UAT
ORANGE 001	INDICATIV NR. STALP PROIECTAT ZONA DJ SI UAT
SL	INDICATIV TIP STALP LEMN EXISTENT UAT
SB	INDICATIV TIP STALP BETON EXISTENT UAT
SC DJ PROIECTAT	INDICATIV TIP STALP COMPOSIT PROIECTAT DJ
SC PROIECTAT	INDICATIV TIP STALP COMPOSIT PROIECTAT UAT
SL DJ	INDICATIV TIP STALP LEMN EXISTENT DJ
SB DJ	INDICATIV TIP STALP BETON EXISTENT DJ
---	STALPI PROIECTATI
---	STALPI EXISTENTI
---	AX DRUM
---	MARGINE DRUM
---	LIMITA PROPRIETATE
---	LIMITA UNITATE ADMINISTRATIV TERITORIALA
---	LIMITA INTRAVILAN

Verificator / Expert	NUME	SEMNATURA	CERINTA
NR. V.566	ING ROTARESCU A. IOAN		A1, A2
REFERAT/EXPERTIZA NR./DATA			
NR. _____ din _____			
PROIECTANT: S.C. HD PROIECTIS S.R.L. Sediul social: Bld. Carol I, Nr.4, Cladirea Habitat Protect, Corp A, Etaj 2, Cam. 205-206, IASI J22/1230/2016 - RO36085083			
SPECIFICATIE	NUME	SEMNATURA	SCARA
SEF PROIECT	ING. PRISACARU ANDREI		1:1000
PROIECTAT	ING. ALUCULESEI C.		DATA:
VERIFICAT	ING. CHERILA IONUT		12.2021
DESEINAT	ARB. LORIN MARTINEUC		
	ORANGE ROMANIA S.A. B-dul Lascar Catargiu, nr. 47-53, Europe House, sector 1, Bucuresti CUI: 9010105, J40/10178/1996		PROIECT NR.: 93 2021
TITLU PROIECT:			Faza:
INSTALARE TRASEU FIBRA OPTICA SUBTERAN SI AERIAN (RETEA FTTH PE STALPI DELGAZ GRID S.A. SI NOI PROIECTATI, IN COMUNA CORDUN, JUDETUL NEAMT)			D.T.A.C. + P.TH.+D.E.
DENUMIRE PLANSA:			PLANSA NR.
PLAN DE SITUATIE			
CU LUCRARI PROIECTATE IN SAT CORDUN, UAT CORDUN, JUD. NEAMT			T1
FORMAT PLANSA: 841mm x 594mm			



LEGENDA

LS	LUNGIME SANT 0.4 x 1.2 m
LT	LATIME TUB
1x40mm	NUMAR x DIAMETRU MONOTUB HOPE PROIECTAT
—	RETEA FO EXISTENTA MONTATA SUBTERAN
—	CANALIZATIE FO SUBTERANA EXISTENTA
—	CAMERETA EXISTENTA
EXISTENTA	INDICATIV NR. CAMERETA EXISTENTA
—	RETEA FO AERIANA PROIECTATA
—	RETEA FO MONTATA SUBTERAN PROIECTATA
DELGAZ 1	INDICATIV NR. STALP BETON EXISTENT IN ZONA DJ SI UAT
TELEKOM 1	INDICATIV NR. STALP LEMN EXISTENT IN ZONA DJ SI UAT
ORANGE 001	INDICATIV NR. STALP PROIECTAT ZONA DJ SI UAT
SL	INDICATIV TIP STALP LEMN EXISTENT UAT
SB	INDICATIV TIP STALP BETON EXISTENT UAT
SC DJ PROIECTAT	INDICATIV TIP STALP COMPOSIT PROIECTAT DJ
SC PROIECTAT	INDICATIV TIP STALP COMPOSIT PROIECTAT UAT
SL DJ	INDICATIV TIP STALP LEMN EXISTENT DJ
SB DJ	INDICATIV TIP STALP BETON EXISTENT DJ
—	STALPI PROIECTATI
—	STALPI EXISTENTI
—	AX DRUM
—	MARGINE DRUM
—	LIMITA PROPRIETATE
—	LIMITA UNITATE ADMINISTRATIV TERITORIALA
—	LIMITA INTRAVILAN



Verificator / Expert	NUME	SEMNATURA	CERINTA
NR. V.566	ING. ROTARESCU A. IOAN		A1, A2
REFERAT/EXPERTIZA NR./DATA			
NR. _____ din _____			
PROIECTANT: S.C. HD PROIECTIS S.R.L. Sediu social: Bld. Carol I, Nr.4, Cladirea Habitat Protect, Corp A, Etaj 2, Cam. 205-206, IASI J22/1230/2016 - RO36085083			
SPECIFICATIE	NUME	SEMNATURA	SCARA:
SEF PROIECT	ING. PRISACARU ANDREI		1:1000
PROIECTAT	ING. ALUCULESEI C.		DATA:
VERIFICAT	ING. CHERILA KONUT		12.2021
DESEINAT	ARB. LORIN MARTINEUC		
	ORANGE ROMANIA S.A. B-dul Lascar Catargiu, nr. 47-53, Europe House, sector 1, Bucuresti CUI: 9010105, J40/10178/1996		PROIECT NR.: 93 2021
TITLU PROIECT:			Faza:
INSTALARE TRASEU FIBRA OPTICA SUBTERAN SI AERIAN (RETEA FTTH PE STALPI DELGAZ GRID S.A. SI NOI PROIECTATI, IN COMUNA CORDUN, JUDETUL NEAMT)			D.T.A.C. + P.TH.+D.E.
DENUMIRE PLANSA:			PLANSĂ NR.:
PLAN DE SITUATIE CU LUCRARI PROIECTATE IN SAT CORDUN, UAT CORDUN, JUD. NEAMT			T3
FORMAT PLANSA: 841mm x 594mm			

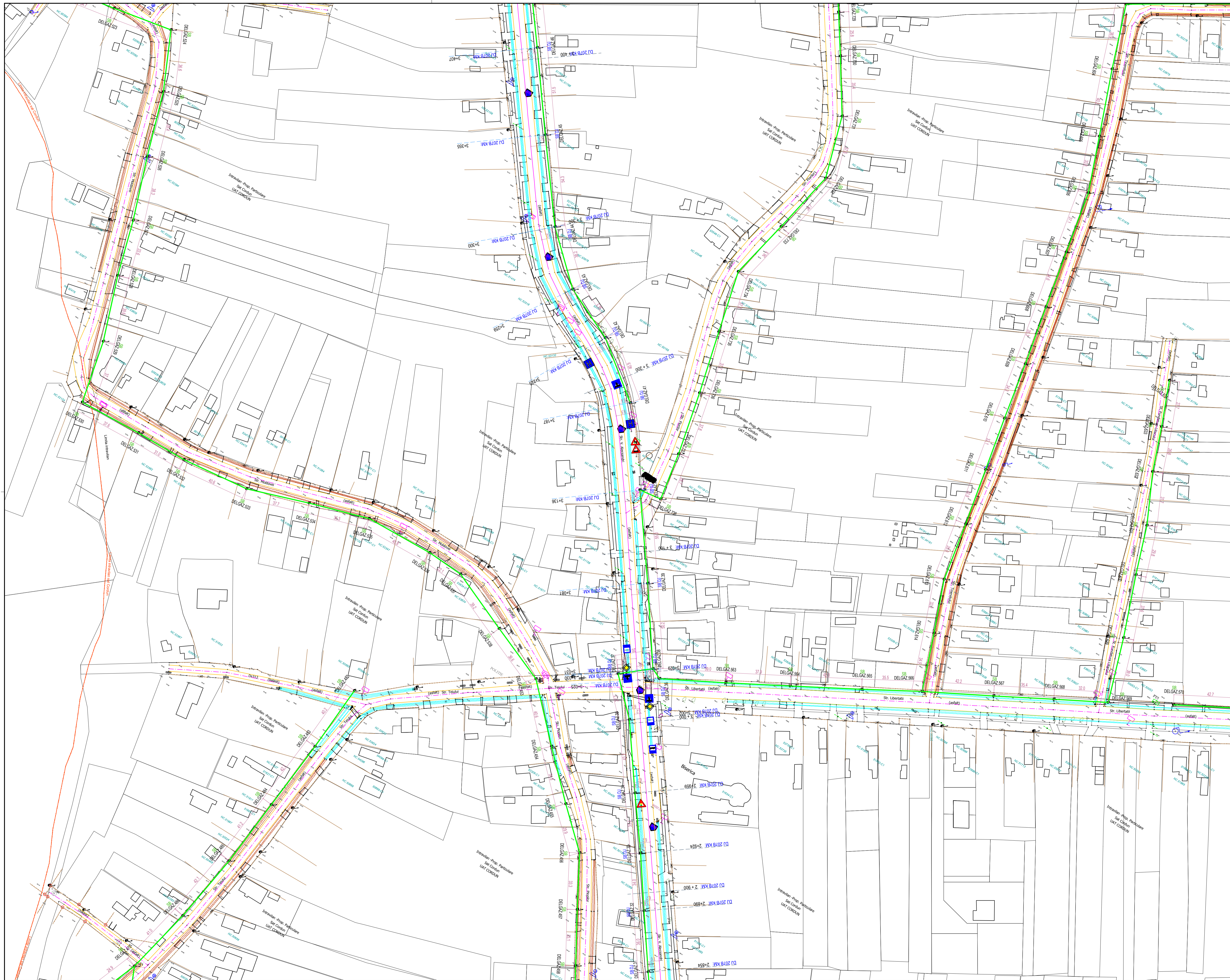

LEGENDA

LS	LUNGIME SANTI 0.4 x 1.2 m
LT	LATIME TUB
1x10mm	NUMAR x DIAMETRU MONOTUB HOPE PROIECTAT
—	RETEA FO EXISTENTA MONTATA SUBTERAN
—	CANALIZATIE FO SUBTERANA EXISTENTA
■	CAMERETA EXISTENTA
■	INDICATIV NR. CAMERETA EXISTENTA
—	RETEA FO AERIANA PROIECTATA
—	RETEA FO MONTATA SUBTERAN PROIECTATA
DELGAZ 1	INDICATIV NR. STALP BETON EXISTENT IN ZONA DJ SI UAT
TELEKOM 1	INDICATIV NR. STALP LEMN EXISTENT IN ZONA DJ SI UAT
ORANGE 001	INDICATIV NR. STALP PROIECTAT ZONA DJ SI UAT
SL	INDICATIV TIP STALP LEMN EXISTENT UAT
SB	INDICATIV TIP STALP BETON EXISTENT UAT
SC DJ PROIECTAT	INDICATIV TIP STALP COMPOSIT PROIECTAT DJ
SC PROIECTAT	INDICATIV TIP STALP COMPOSIT PROIECTAT UAT
SL DJ	INDICATIV TIP STALP LEMN EXISTENT DJ
SB DJ	INDICATIV TIP STALP BETON EXISTENT DJ
■	STALPI PROIECTATI
■	STALPI EXISTENTI
—	AX DRUM
—	MARGINE DRUM
—	LIMITA PROPRIETATE
—	LIMITA LANTATE ADMINISTRATIV TERITORIALA
—	LIMITA INTRAVILAN



Verificator / Expert	NUME	SEMNATURA	CERINTA
NR. V.566	ING ROTARESCU A. IOAN		A1, A2
REFERAT/EXPERTIZA NR./DATA			
NR. _____ din _____			
PROIECTANT: S.C. HD PROIECTIS S.R.L. Sediul social: Bld. Carol I, Nr.4, Cladirea Habitat Protect, Corp A, Etaj 2, Cam. 205-206, IASI J22/1230/2016 - R036085083			
SPECIFICATIE	NUME	SEMNATURA	SCARA
SEF PROIECT	ING. PRISACARU ANDREI		1:1000
PROIECTAT	ING. ALICULESEI C.		DATA:
VERIFICAT	ING. CHRISLA IONUT		12.2021
DESEINAT	ARB. LORIN MARTINEUC		
	ORANGE ROMANIA S.A. B-dul Lascar Catargiu, nr. 47-53, Europe House, sector 1, Bucuresti CUI: 9010105, 340/10178/1996		PROIECT NR.: 93 2021
TITLU PROIECT: INSTALARE TRASEU FIBRA OPTICA SUBTERAN SI AERIAN (RETEA FTTH PE STALPI DELGAZ GRID S.A. SI NOI PROIECTATI, IN COMUNA CORDUN, JUDETUL NEAMT)			Faza: D.T.A.C. P.TH.+D.E.
DENUMIRE PLANSA: PLAN DE SITUATIE CU LUCRARI PROIECTATE IN SAT CORDUN, UAT CORDUN, JUD. NEAMT			PLANSĂ NR. 14
FORMAT PLANSA: 841mm x 594mm			



LEGENDA

LS	LUNGIME SANT 0.4 x 1.2 m
LT	LATIME TUB
1x10mm	NUMAR x DIAMETRU MONOTUB HOPE PROIECTAT
---	RETEA FO EXISTENTA MONTATA SUBTERAN
---	CANALIZATIE FO SUBTERANA EXISTENTA
---	CAMERETA EXISTENTA
---	EXISTENTA
---	INDICATIV NR. CAMERETA EXISTENTA
---	RETEA FO AERIANA PROIECTATA
---	RETEA FO MONTATA SUBTERAN PROIECTATA
DELGAZ 1	INDICATIV NR. STALP BETON EXISTENT IN ZONA DJ SI UAT
TELEKOM 1	INDICATIV NR. STALP LEMN EXISTENT IN ZONA DJ SI UAT
ORANGE 001	INDICATIV NR. STALP PROIECTAT ZONA DJ SI UAT
SL	INDICATIV TIP STALP LEMN EXISTENT UAT
SB	INDICATIV TIP STALP BETON EXISTENT UAT
SC DJ PROIECTAT	INDICATIV TIP STALP COMPOSIT PROIECTAT DJ
SC PROIECTAT	INDICATIV TIP STALP COMPOSIT PROIECTAT UAT
SL DJ	INDICATIV TIP STALP LEMN EXISTENT DJ
SB DJ	INDICATIV TIP STALP BETON EXISTENT DJ
---	STALPI PROIECTATI
---	STALPI EXISTENTI
---	AX DRUM
---	MARGINE DRUM
---	LIMITA PROPRIETATE
---	LIMITA UNITATE ADMINISTRATIV TERITORIALA
---	LIMITA INTRAVILAN

COMPASS

Verificator / Expert	NUME	SEMNTURA	CERINTA
NR. V.566	ING. ROTARESCU A. IOAN		A1, A2
REFERAT/EXPERTIZA NR./DATA			
NR. _____ din _____			
PROIECTANT: S.C. HD PROIECTIS S.R.L. Sediul social: Bld. Carol I, Nr.4, Cladirea Habitat Proiect, Corp A, Etaj 2, Cam. 205-206, IASI J22/1230/2016 - R036085083			
SPECIFICATIE	NUME	SEMNTURA	SCARA:
SEF PROIECT	ING. PRISACARU ANDREI		1:1000
PROIECTAT	ING. ALUCULESEI C.		DATA:
VERIFICAT	ING. CHRISLA IONUT		12.2021
DESEINAT	ARH. LORIN MARTINEC		
	ORANGE ROMANIA S.A. B-dul Lascar Catargiu, nr. 47-53, Europe House, sector 1, Bucuresti CUI: 9010105, 340/10178/1996		PROIECT NR.: 93 2021
TITLU PROIECT: INSTALARE TRASEU FIBRA OPTICA SUBTERAN SI AERIAN (RETEA FTTH PE STALPI DELGAZ GRID S.A. SI NOI PROIECTATI, IN COMUNA CORDUN, JUDETUL NEAMT)			Faza: D.T.A.C. P.TH.+D.E.
DENUMIRE PLANSA: PLAN DE SITUATIE CU LUCRARI PROIECTATE IN SAT CORDUN, UAT CORDUN, JUD. NEAMT			PLANSA NR. 15
FORMAT PLANSA: 841mm x 594mm			

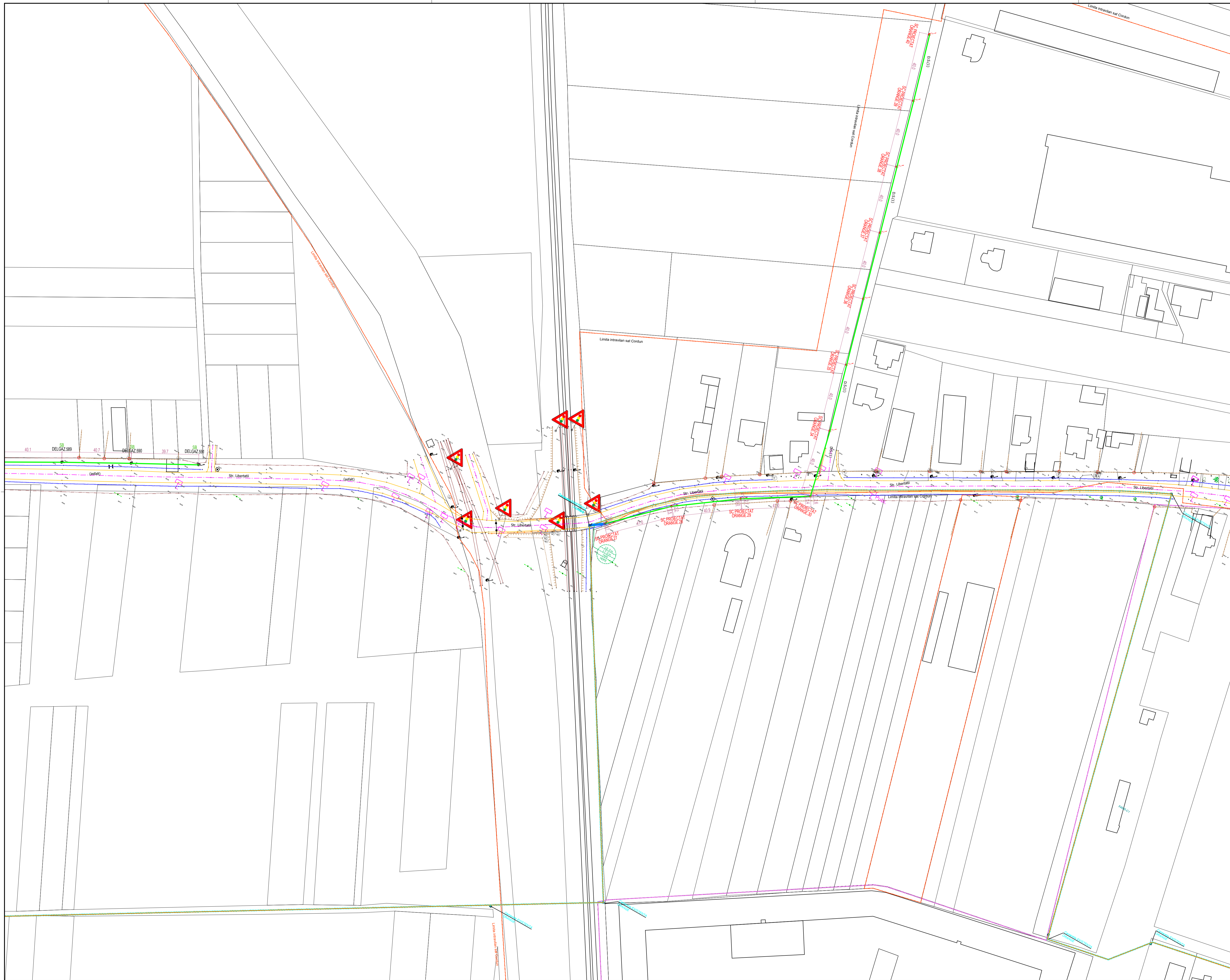

LEGENDA

LS	LUNGIME SANT 0.4 x 1.2 m
LT	LATIME TUB
1x10mm	NUMAR x DIAMETRU MONOTUB HOPE PROIECTAT
—	RETEA FO EXISTENTA MONTATA SUBTERAN
—	CANALIZATIE FO SUBTERANA EXISTENTA
—	CAMERETA EXISTENTA
—	INDICATIV NR. CAMERETA EXISTENTA
—	RETEA FO AERIANA PROIECTATA
—	RETEA FO MONTATA SUBTERAN PROIECTATA
DELGAZ 1	INDICATIV NR. STALP BETON EXISTENT IN ZONA DJ SI UAT
TELEKOM 1	INDICATIV NR. STALP LEMN EXISTENT IN ZONA DJ SI UAT
ORANGE 001	INDICATIV NR. STALP PROIECTAT ZONA DJ SI UAT
SL	INDICATIV TIP STALP LEMN EXISTENT UAT
SB	INDICATIV TIP STALP BETON EXISTENT UAT
SC DJ PROIECTAT	INDICATIV TIP STALP COMPOSIT PROIECTAT DJ
SC PROIECTAT	INDICATIV TIP STALP COMPOSIT PROIECTAT UAT
SL DJ	INDICATIV TIP STALP LEMN EXISTENT DJ
SB DJ	INDICATIV TIP STALP BETON EXISTENT DJ
—	STALPI PROIECTATI
—	STALPI EXISTENTI
—	AX DRUM
—	MARGINE DRUM
—	LIMITA PROPRIETATE
—	LIMITA UNITATE ADMINISTRATIV TERITORIALA
—	LIMITA INTRAVILAN



Verificator / Expert	NUME	SEMNATURA	CERINTA
NR. V.566	ING ROTARESCU A. IOAN		A1, A2
REFERAT/EXPERTIZA NR./DATA			
NR. _____ din _____			

PROIECTANT: **S.C. HD PROIECTIS S.R.L.**
 Sediul societii: Blvd. Carol I, Nr.4, Cladirea Habitat Protect, Corp A, Etaj 2, Cam. 205-206, IASI
J22/1230/2016 - R036085083

SPECIFICATIE	NUME	SEMNATURA	SCARA:
SEF PROIECT	ING. PRISACARU ANDREI		1:1000
PROIECTAT	ING. ALUCULESEI C.		DATA:
VERIFICAT	ING. CHRISLA IONUT		12.2021
DESEINAT	ARB. LORIN MARTINEUC		

ORANGE ROMANIA S.A.
 B-dul Lascar Catargiu, nr. 47-53, Europe House, sector 1, Bucuresti
 CUI: 9010105, J40/10178/1996

TITLU PROIECT:
 INSTALARE TRASEU FIBRA OPTICA SUBTERAN SI AERIAN (RETEA FTTH PE STALPI DELGAZ GRID S.A. SI NOI PROIECTATI, IN COMUNA CORDUN, JUDETUL NEAMT)

DENUMIRE PLANSA:
 PLAN DE SITUATIE
 CU LUCRARI PROIECTATE IN SAT CORDUN, UAT CORDUN, JUD. NEAMT



LEGENDA

LS	LUNGIME SANTI 0.4 x 1.2 m
LT	LATIME TUB
140mm	NUMAR x DIAMETRU MONOTUB HOPE PROIECTAT
[Orange line]	RETEA FO EXISTENTA MONTATA SUBTERAN
[Blue line]	CANALIZATIE FO SUBTERANA EXISTENTA
[Green line]	CAMERETA EXISTENTA
[Red line]	INDICATIV NR. CAMERETA EXISTENTA
[Yellow line]	RETEA FO AERIANA PROIECTATA
[Purple line]	RETEA FO MONTATA SUBTERANA PROIECTATA
DELGAZ 1	INDICATIV NR. STALP BETON EXISTENT IN ZONA DJ SI UAT
TELEKOM 1	INDICATIV NR. STALP LEHM EXISTENT IN ZONA DJ SI UAT
ORANGE.001	INDICATIV NR. STALP PROIECTAT ZONA DJ SI UAT
SL	INDICATIV TIP STALP LEHM EXISTENT UAT
SB	INDICATIV TIP STALP BETON EXISTENT UAT
SC DJ PROIECTAT	INDICATIV TIP STALP COMPOSIT PROIECTAT DJ
SC PROIECTAT	INDICATIV TIP STALP COMPOSIT PROIECTAT UAT
SL DJ	INDICATIV TIP STALP LEHM EXISTENT DJ
SB DJ	INDICATIV TIP STALP BETON EXISTENT DJ
[Red circle]	STALPI PROIECTATI
[Blue circle]	STALPI EXISTENTI
[Black line]	AX DRUM
[Orange line]	MARGINE DRUM
[Blue line]	LIMITA PROPRIETATE
[Purple line]	LIMITA UNITATE ADMINISTRATIV TERITORIALA
[Red line]	LIMITA INTRAVILAN

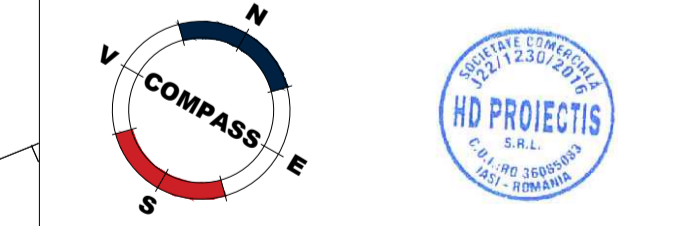

Verificator / Expert	NUME	SEMNATURA	CERINTA
NR. V.566	ING ROTARESCU A. IOAN	[Signature]	A1, A2
REFERAT/EXPERTIZA NR./DATA			
NR. _____ din _____			
PROIECTANT: S.C. HD PROIECTIS S.R.L. Sediul social: Bld. Carol I, Nr.4, Cladirea Habitat Protect, Corp A, Etaj 2, Cam. 205-206, IASI J22/1230/2016 - R036085083			
SPECIFICATIE	NUME	SEMNATURA	SCARA:
SEF PROIECT	ING. PRISACARU ANDREI	[Signature]	1:1000
PROIECTAT	ING. ALUCULESEI C.	[Signature]	DATA:
VERIFICAT	ING. CHRISLA KONUT	[Signature]	12.2021
DESEINAT	ARB. LORIN MARTINEC	[Signature]	
	ORANGE ROMANIA S.A. B-dul Lascar Catargiu, nr. 47-53, Europe House, sector 1, Bucuresti CUI: 9010105, J40/10178/1996		PROIECT NR.: 93 2021
TITLU PROIECT: INSTALARE TRASEU FIBRA OPTICA SUBTERAN SI AERIAN (RETEA FTTH PE STALPI DELOAZ GRID S.A. SI NOI PROIECTATI, IN COMUNA CORDUN, JUDETUL NEAMT)			Faza: D.T.A.C. P.TH.+D.E.
DENUMIRE PLANSA: PLAN DE SITUATIE CU LUCRARI PROIECTATE IN SAT CORDUN, UAT CORDUN, JUD. NEAMT			PLANSA NR. 17
FORMAT PLANSA: 841mm x 594mm			

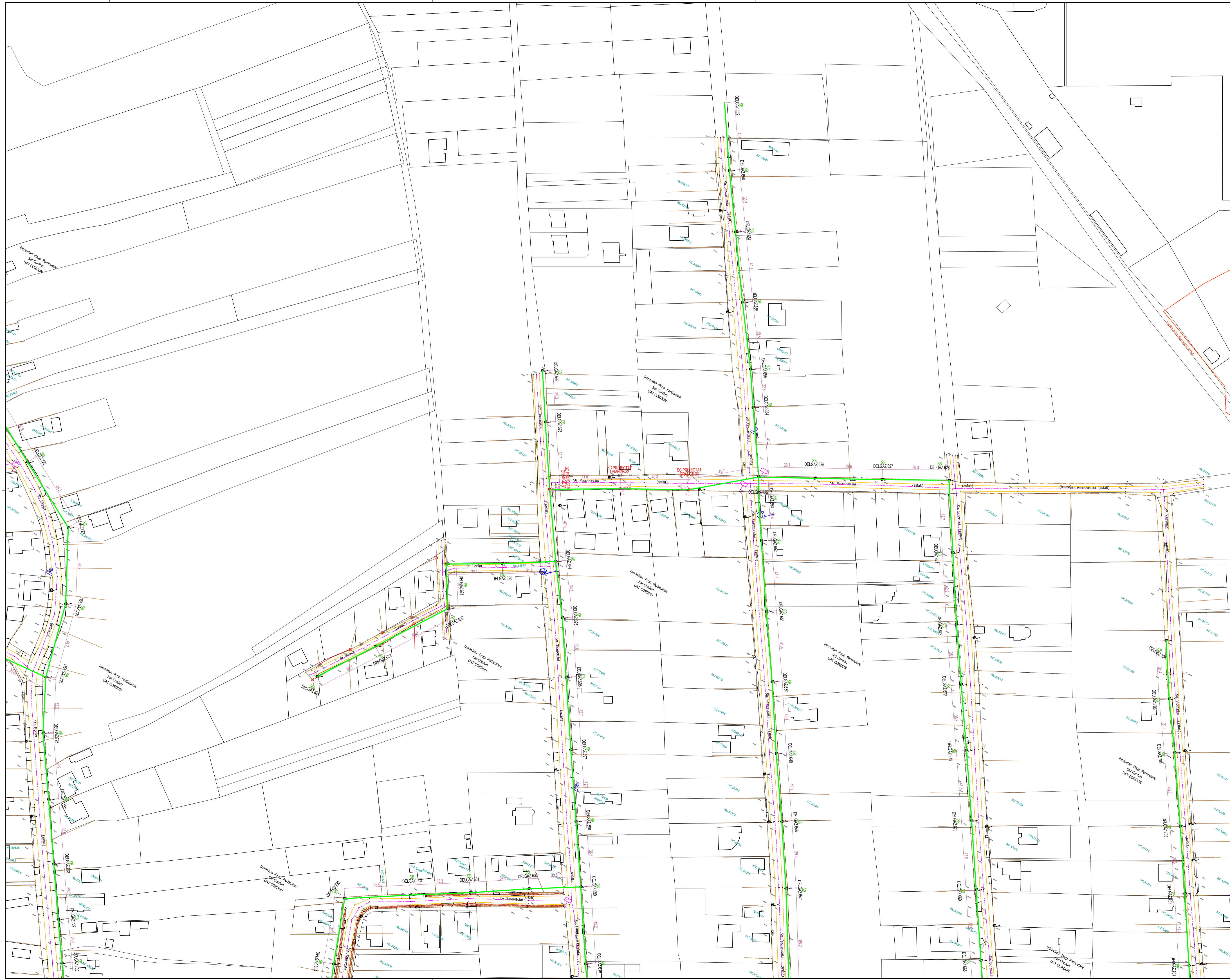

LEGENDA

LS	LUNGIME SANT 0.4 x 1.2 m
LT	LATIME TUB
1x40mm	NUMAR x DIAMETRU MONOTUB HOPE PROIECTAT
[Orange line]	RETEA FO EXISTENTA MONTATA SUBTERAN
[Blue line]	CANALIZATIE FO SUBTERANA EXISTENTA
[Green line]	CAMERETA EXISTENTA
[Green line]	INDICATIV NR. CAMERETA EXISTENTA
[Green line]	RETEA FO AERIANA PROIECTATA
[Green line]	RETEA FO MONTATA SUBTERAN PROIECTATA
DELGAZ 1	INDICATIV NR. STALP BETON EXISTENT IN ZONA DJ SI UAT TELEKOM 1
DELGAZ 2	INDICATIV NR. STALP LEMN EXISTENT IN ZONA DJ SI UAT
ORANGE 001	INDICATIV NR. STALP PROIECTAT ZONA DJ SI UAT
SL	INDICATIV TIP STALP LEMN EXISTENT UAT
SB	INDICATIV TIP STALP BETON EXISTENT UAT
SC DJ PROIECTAT	INDICATIV TIP STALP COMPOSIT PROIECTAT DJ
SC PROIECTAT	INDICATIV TIP STALP COMPOSIT PROIECTAT UAT
SL DJ	INDICATIV TIP STALP LEMN EXISTENT DJ
SB DJ	INDICATIV TIP STALP BETON EXISTENT DJ
[Green circle]	STALPI PROIECTATI
[Black circle]	STALPI EXISTENTI
[Dashed line]	AX DRUM
[Dashed line]	MARGINE DRUM
[Dashed line]	LIMITA PROPRIETATE
[Dashed line]	LIMITA UNITATE ADMINISTRATIV TERITORIALA
[Dashed line]	LIMITA INTRAVILAN



Verificator / Expert	NUME	SEMNTURA	CERINTA
NR. V.566	ING. ROTARESCU A. IOAN	[Signature]	A1, A2
REFERAT/EXPERTIZA NR./DATA			
NR. _____ din _____			
PROIECTANT: S.C. HD PROIECTIS S.R.L. Sediul social: Bld. Carol I, Nr.4, Cladirea Habitat Proiect, Corp A, Etaj 2, Cam. 205-206, IASI J22/1230/2016 - R036085083			
SPECIFICATIE	NUME	SEMNTURA	SCARA
SEF PROIECT	ING. PRISACARU ANDREI	[Signature]	1:1000
PROIECTAT	ING. ALUCULESEI C.	[Signature]	DATA:
VERIFICAT	ING. CHRISLA IONUT	[Signature]	12.2021
DESEAT	ARB. LORIN MARTINEUC	[Signature]	
ORANGE ROMANIA S.A. B-dul Lascar Catargiu, nr. 47-53, Europe House, sector 1, Bucuresti CUI: 9010105, J40/10178/1996			PROIECT NR.: 93 2021
TITLU PROIECT: INSTALARE TRASEU FIBRA OPTICA SUBTERAN SI AERIAN (RETEA FTTH PE STALPI DELGAZ GRID S.A. SI NOI PROIECTATI, IN COMUNA CORDUN, JUDEUL NEAMT)			Faza: D.T.A.C. P.TH.+D.E.
DENUMIRE PLANSA: PLAN DE SITUATIE CU LUCRARI PROIECTATE IN SAT CORDUN, UAT CORDUN, JUD. NEAMT			PLANSA NR. 18
FORMAT PLANSA: 841mm x 594mm			

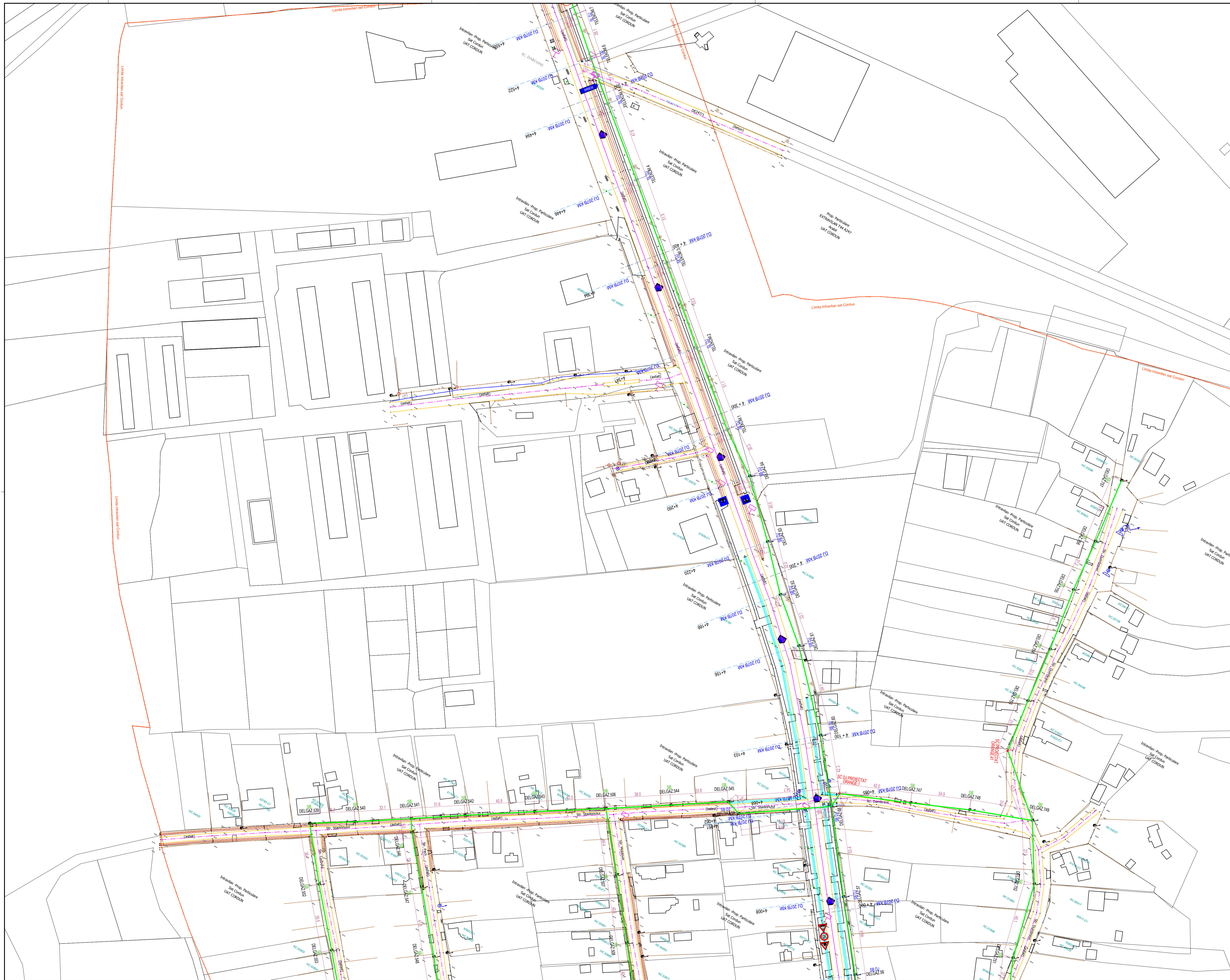

LEGENDA

LS	LUNGIME SANT 0.4 x 1.2 m
LT	LATIME TUB
1x10mm	NUMAR x DIAMETRU MONOTUB HOPE PROIECTAT
	RETEA FO EXISTENTA MONTATA SUBTERAN
	CANALIZATIE FO SUBTERANA EXISTENTA
	CAMERETA EXISTENTA
	INDICATIV NR. CAMERETA EXISTENTA
	RETEA FO AERIANA PROIECTATA
	RETEA FO MONTATA SUBTERAN PROIECTATA
DELGAZ 1	INDICATIV NR. STALP BETON EXISTENT IN ZONA DJ SI UAT
TELEKOM 1	INDICATIV NR. STALP LEMN EXISTENT IN ZONA DJ SI UAT
ORANGE.001	INDICATIV NR. STALP PROIECTAT ZONA DJ SI UAT
SL	INDICATIV TIP STALP LEMN EXISTENT UAT
SB	INDICATIV TIP STALP BETON EXISTENT UAT
SC DJ PROIECTAT	INDICATIV TIP STALP COMPOSIT PROIECTAT DJ
SC PROIECTAT	INDICATIV TIP STALP COMPOSIT PROIECTAT UAT
SL DJ	INDICATIV TIP STALP LEMN EXISTENT DJ
SB DJ	INDICATIV TIP STALP BETON EXISTENT DJ
	STALPI PROIECTATI
	STALPI EXISTENTI
	AX DRUM
	MARGINE DRUM
	LIMITA PROPRIETATE
	LIMITA UNITATE ADMINISTRATIV TERITORIALA
	LIMITA INTRAVILAN



Verificator / Expert	NUME	SEMNATURA	CERINTA
NR. V.566	ING. ROTARESCU A. IOAN		A1, A2
REFERAT/EXPERTIZA NR./DATA			
NR. _____ din _____			
PROIECTANT: S.C. HD PROIECTIS S.R.L. Sediul societati: Bld. Carol I, Nr.4, Cladirea Habitat Protect, Corp A, Etaj 2, Cam. 205-206, IASI CUI: 205-206, IASI J22/1230/2016 - R036085083			
SPECIFICATIE	NUME	SEMNATURA	SCARA
SEF PROIECT	ING. PRISACARU ANDREI		1:1000
PROIECTAT	ING. ALUCULESI C.		DATA:
VERIFICAT	ING. CHIRILA IONUT		12.2021
DESEINAT	ARB. LORIN MARTINEUC		
	ORANGE ROMANIA S.A. B-dul Lascar Catargiu, nr. 47-53, Europe House, sector 1, Bucuresti CUI: 9010105, 340/10178/1996		PROIECT NR.: 93 2021
TITLU PROIECT: INSTALARE TRASEU FIBRA OPTICA SUBTERAN SI AERIAN (RETEA FTTH PE STALPI DELGAZ GRID S.A. SI NOI PROIECTATI, IN COMUNA CORDUN, JUDETUL NEAMT)			FAZA: D.T.A.C. P.TH.+D.E.
DENUMIRE PLANSA: PLAN DE SITUATIE CU LUCRARI PROIECTATE IN SAT CORDUN, UAT CORDUN, JUD. NEAMT			PLANSA NR.: 19
FORMAT PLANSA: 841mm x 594mm			

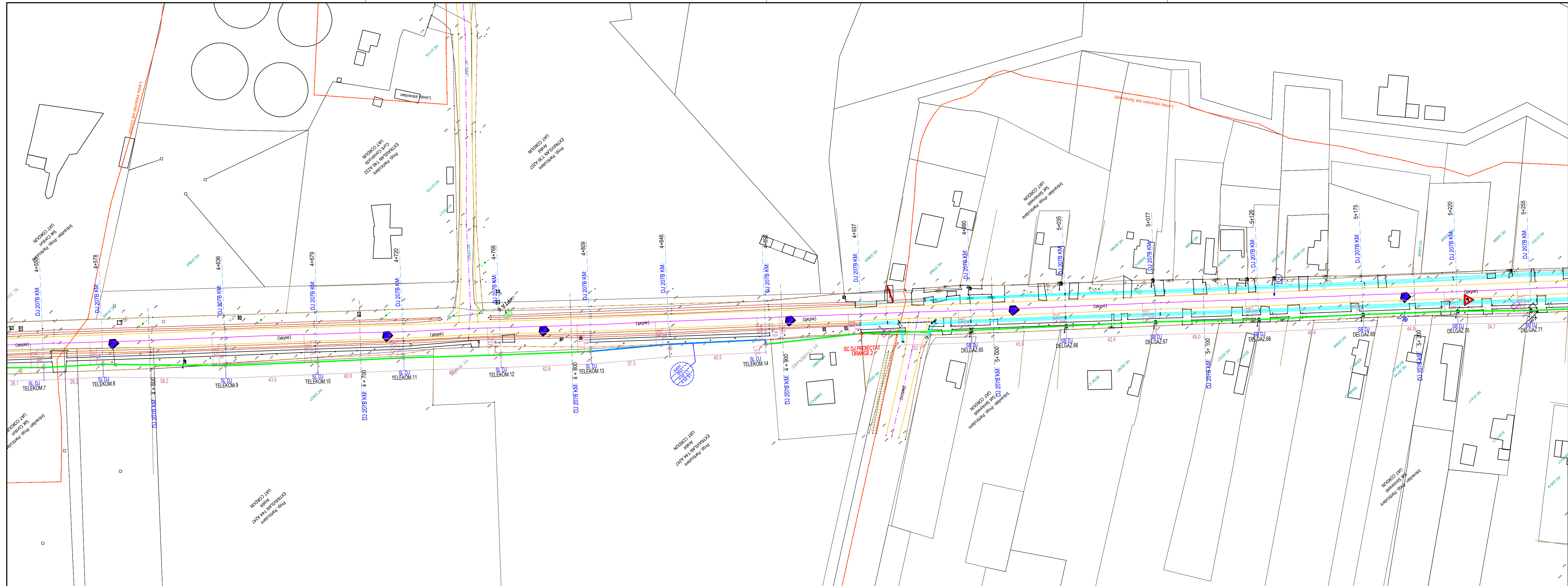

LEGENDA	
LS.	LUNGIME SANT 0.4 x 1.2 m
LT.	LATIME TUB
1x40mm	NUMAR x DIAMETRU MONOTUB HDPE PROIECTAT
—	RETEA FO EXISTENTA MONTATA SUBTERAN
—	CANALIZATIE FO SUBTERANA EXISTENTA
■	CAMERETA EXISTENTA
■	EXISTENTA
■	RETEA FO AERIANA EXISTENTA
■	RETEA FO MONTATA SUBTERAN PROIECTATA
DELGAZ.1	INDICATIV NR. STALP BETON EXISTENT IN ZONA DJ SI UAT
TELEKOM.1	INDICATIV NR. STALP LEMN EXISTENT IN ZONA DJ SI UAT
ORANGE.001	INDICATIV NR. STALP PROIECTAT ZONA DJ SI UAT
SL	INDICATIV TIP STALP LEMN EXISTENT UAT
SB	INDICATIV TIP STALP BETON EXISTENT UAT
SC DJ PROIECTAT	INDICATIV TIP STALP COMPOSIT PROIECTAT DJ
SC PROIECTAT	INDICATIV TIP STALP COMPOSIT PROIECTAT UAT
SL DJ	INDICATIV TIP STALP LEMN EXISTENT DJ
SB DJ	INDICATIV TIP STALP BETON EXISTENT DJ
■	STALPI PROIECTATI
■	STALPI EXISTENTI
—	AX DRUM
—	MARGINE DRUM
—	LIMITA PROPRIETATE
—	LIMITA UNITATE ADMINISTRATIV TERITORIALA
—	LIMITA INTRAVILAN

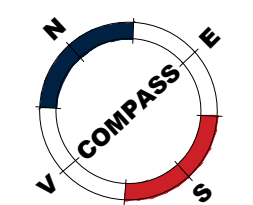

Verificator / Expert NR. V.566	NUME ING. ROTARESCU A. IOAN	SEMNATURA	CERINTA A1, A2
PROIECTANT: HD PROIECTIS	S.C. HD PROIECTIS S.R.L. Sediu social: Bld. Carol I, Nr.4, Cladirea Habitat Project, Corp A, Etaj 2, Cam. 205-206, IASI J22/1230/2016 - RO36085083		
FORMAT PLANSA: 297 x 950 mm			
SPECIFICATIE	NUME	SEMNATURA	SCARA:
SEF PROIECT	ING. PRISACARU ANDREI		1:1000
PROIECTAT	ING. ALIUCULESEI C.		DATA:
VERIFICAT	ING. CHIRILA IONUT		12.2021
DESENAT	ARH. LORIN MARTINIUC		

REFERAT/EXPERTIZA NR./DATA	PROIECT NR.:
	93
ORANGE ROMANIA S.A. B-dul Lascar Catargiu, nr. 47-53, Europe House, sector 1, Bucuresti CUI: 9010105, J40/10178/1996	2021
TITLU PROIECT: INSTALARE TRASEU FIBRA OPTICA SUBTERAN SI AERIAN (RETEA FTTH) PE STALPII DELGAZ GRID S.A. SI NOI PROIECTATI, IN COMUNA CORDUN, JUDETUL NEAMT	Faza: D.T.A.C. + P.TH.+D.E.
DENUMIRE PLANSA: PLAN DE SITUATIE CU LUCRARI PROIECTATE IN SAT CORDUN, SAT SIMONESTI, UAT CORDUN, JUDETUL NEAMT	PLANSA NR.:
	T10

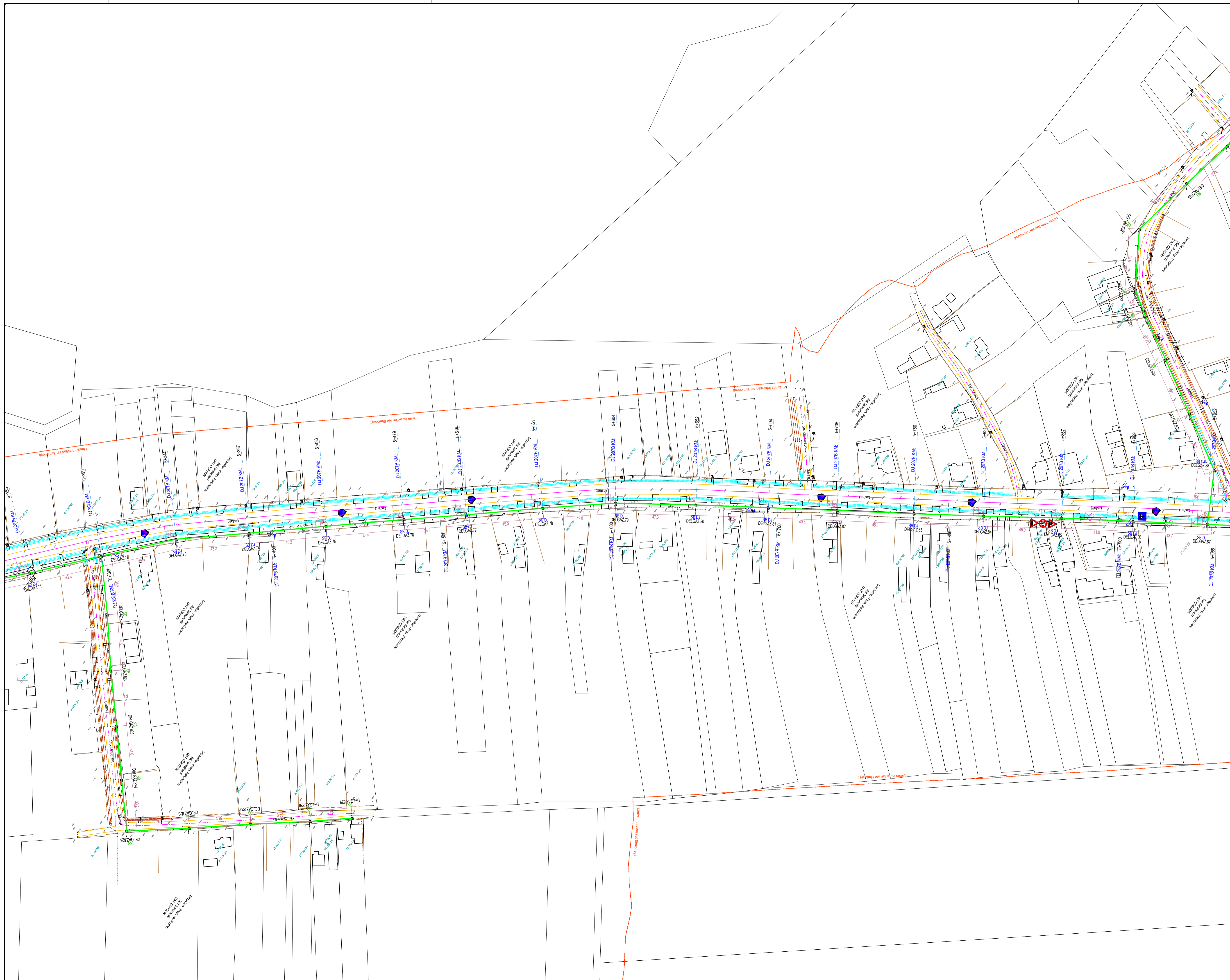

LEGENDA

LS	LUNGIME SANT 0.4 x 1.2 m
LT	LATIME TUB
1x40mm	NUMAR x DIAMETRU MONOTUB HOPE PROIECTAT
(Blue line)	RETEA FO EXISTENTA MONTATA SUBTERAN
(Orange line)	CANALIZATIE FO SUBTERANA EXISTENTA
(Green line)	CAMERETA EXISTENTA
(Light blue line)	EXISTENTA INDICATIV NR. CAMERETA EXISTENTA
(Light green line)	RETEA FO AERIANA PROIECTATA
(Light blue line)	RETEA FO MONTATA SUBTERANA PROIECTATA
(Blue line)	DELAGAZ 1 INDICATIV NR. STALP BETON EXISTENT IN ZONA DJ SI UAT
(Blue line)	TELEKOM 1 INDICATIV NR. STALP LEMN EXISTENT IN ZONA DJ SI UAT
(Orange line)	ORANGE.001 INDICATIV NR. STALP PROIECTAT ZONA DJ SI UAT
(Blue line)	SL INDICATIV TIP STALP LEMN EXISTENT UAT
(Blue line)	SB INDICATIV TIP STALP BETON EXISTENT UAT
(Blue line)	SC DJ PROIECTAT INDICATIV TIP STALP COMPOSIT PROIECTAT DJ
(Blue line)	SC PROIECTAT INDICATIV TIP STALP COMPOSIT PROIECTAT UAT
(Blue line)	SL DJ INDICATIV TIP STALP LEMN EXISTENT DJ
(Blue line)	SB DJ INDICATIV TIP STALP BETON EXISTENT DJ
(Blue line)	STALPI PROIECTATI
(Blue line)	STALPI EXISTENTI
(Blue line)	AX DRUM
(Blue line)	MARGINE DRUM
(Blue line)	LIMITA PROPRIETATE
(Blue line)	LIMITA UNITATE ADMINISTRATIV TERITORIALA
(Blue line)	LIMITA INTRAVILAN

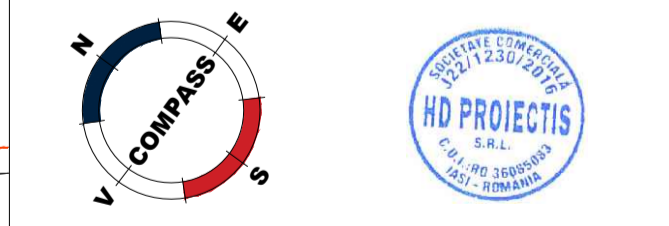

Verificator / Expert	NUME	SEMNATURA	CERINTA
NR. V.566	ING ROTARESCU A. IOAN		A1, A2
REFERAT/EXPERTIZA NR./DATA			
NR. _____ din _____			
PROIECTANT: S.C. HD PROIECTIS S.R.L. Sediul social: Bld. Carol I, Nr.4, Cladirea Habitat Protect, Corp A, Etaj 2, Cam. 205-206, IASI J22/1230/2016 - R036085083			
SPECIFICATIE	NUME	SEMNATURA	SCARA
SEF PROIECT	ING. PRISACARU ANDREI		1:1000
PROIECTAT	ING. ALUCULESEI C.		DATA:
VERIFICAT	ING. CHRISLA IONUT		12.2021
DESEINAT	ARH. LORIN MARTINEUC		
	ORANGE ROMANIA S.A. B-dul Lascar Catargiu, nr. 47-53, Europe House, sector 1, Bucuresti CUI: 9010105, J40/10178/1996		PROIECT NR.: 93 2021
TITLU PROIECT:			Faza:
INSTALARE TRASEU FIBRA OPTICA SUBTERAN SI AERIAN (RETEA FTTH PE STALPI DELAGAZ GRID S.A. SI NOI PROIECTATI, IN COMUNA CORDUN, JUDETUL NEAMT			D.T.A.C. * P.TH.+D.E.
DENUMIRE PLANSA:			PLANSA NR.
PLAN DE SITUATIE CU LUCRARI PROIECTATE IN SAT SIMONESTI, UAT CORDUN, JUD. NEAMT			T11
FORMAT PLANSA: 841mm x 594mm			

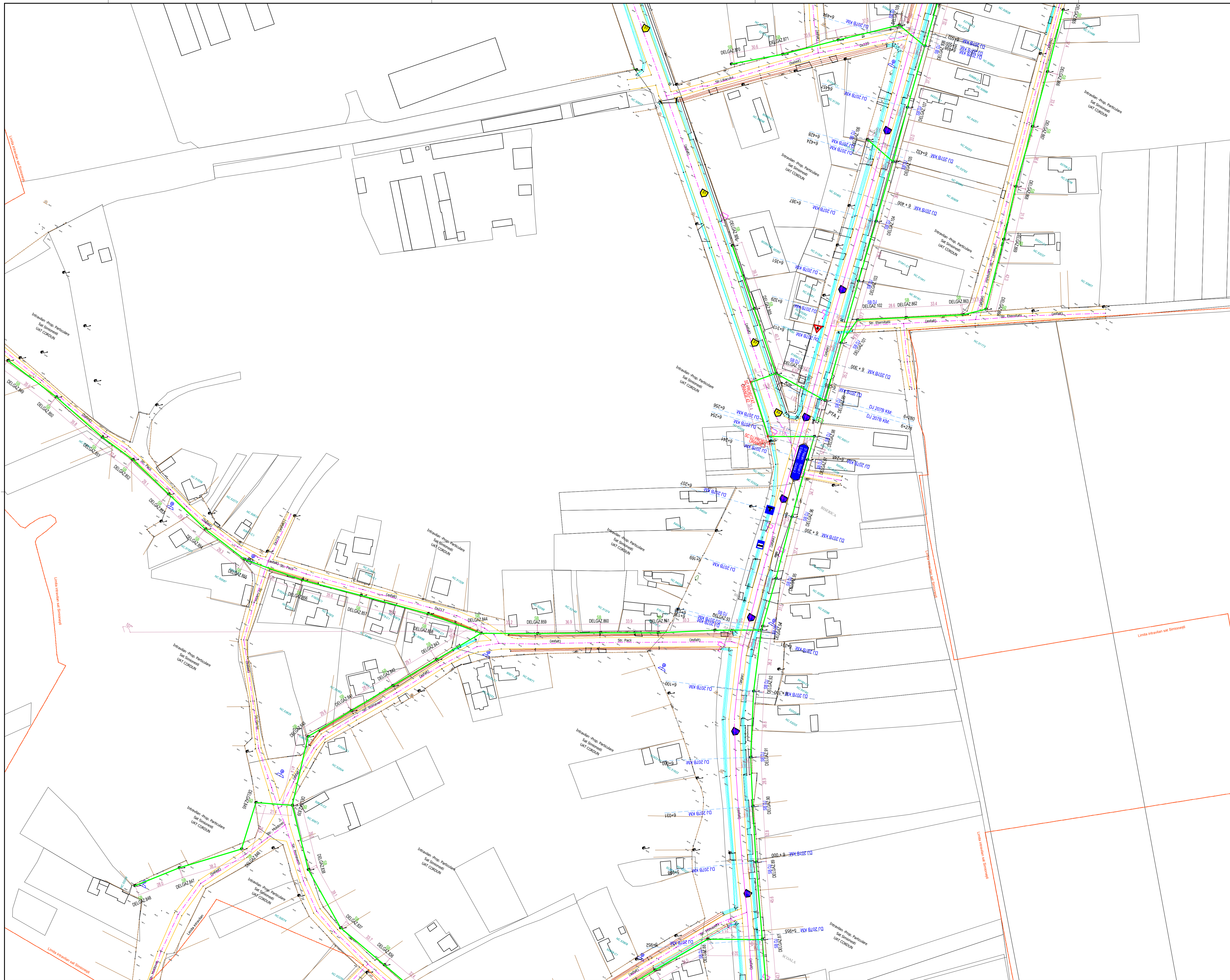

LEGENDA

LS	LUNGIME SANT 0.4 x 1.2 m
LT	LATIME TUB
1x40mm	NUMAR x DIAMETRU MONOTUB HOPE PROIECTAT
	RETEA FO EXISTENTA MONTATA SUBTERAN
	CANALIZATIE FO SUBTERANA EXISTENTA
	CAMERETA EXISTENTA
	EXISTENTA
	INDICATIV NR. CAMERETA EXISTENTA
	RETEA FO AERIANA PROIECTATA
	RETEA FO MONTATA SUBTERAN PROIECTATA
DELGAZ 1	INDICATIV NR. STALP BETON EXISTENT IN ZONA DJ SI UAT
TELEKOM 1	INDICATIV NR. STALP LEMN EXISTENT IN ZONA DJ SI UAT
ORANGE 001	INDICATIV NR. STALP PROIECTAT ZONA DJ SI UAT
SL	INDICATIV TIP STALP LEMN EXISTENT UAT
SB	INDICATIV TIP STALP BETON EXISTENT UAT
SC DJ PROIECTAT	INDICATIV TIP STALP COMPOSIT PROIECTAT DJ
SC PROIECTAT	INDICATIV TIP STALP COMPOSIT PROIECTAT UAT
SL DJ	INDICATIV TIP STALP LEMN EXISTENT DJ
SB DJ	INDICATIV TIP STALP BETON EXISTENT DJ
	STALPI PROIECTATI
	STALPI EXISTENTI
	AX DRUM
	MARGINE DRUM
	LIMITA PROPRIETATE
	LIMITA UNITATE ADMINISTRATIV TERITORIALA
	LIMITA INTRAVILAN



Verificator / Expert	NUME	SEMNTURA	CERINTA
NR. V.566	ING ROTARESCU A. IOAN		A1, A2
REFERAT/EXPERTIZA NR./DATA			
NR. _____ din _____			
PROIECTANT: S.C. HD PROIECTIS S.R.L. Sediul social: Bld. Carol I, Nr.4, Cladirea Habitat Proiect, Corp A, Etaj 2. Cam. 205-206, IASI J22/1230/2016 - R036085083			
SPECIFICATIE	NUME	SEMNTURA	SCARA
SEF PROIECT	ING. PRISACARU ANDREI		1:1000
PROIECTAT	ING. ALUCULESEI C.		DATA:
VERIFICAT	ING. CHRISLA IONUT		12.2021
DESEAT	ARB. LORIN MARTINEUC		
	ORANGE ROMANIA S.A. B-dul Lascar Catargiu, nr. 47-53, Europe House, sector 1, Bucuresti CUI: 9010105, 340/10178/1996		PROIECT NR.: 93 2021
TITLU PROIECT:			Faza:
INSTALARE TRASEU FIBRA OPTICA SUBTERAN SI AERIAN (RETEA FTTH PE STALPI) DELGAZ GRID S.A. SI NOI PROIECTATI, IN COMUNA CORDUN, JUDETUL NEAMT			D.T.A.C. P.TH.+D.E.
DENUMIRE PLANSA:			PLANSA NR.
PLAN DE SITUATIE CU LUCRARI PROIECTATE IN SAT SIMONESTI, UAT CORDUN, JUD. NEAMT			T12
FORMAT PLANSA: 841mm x 594mm			

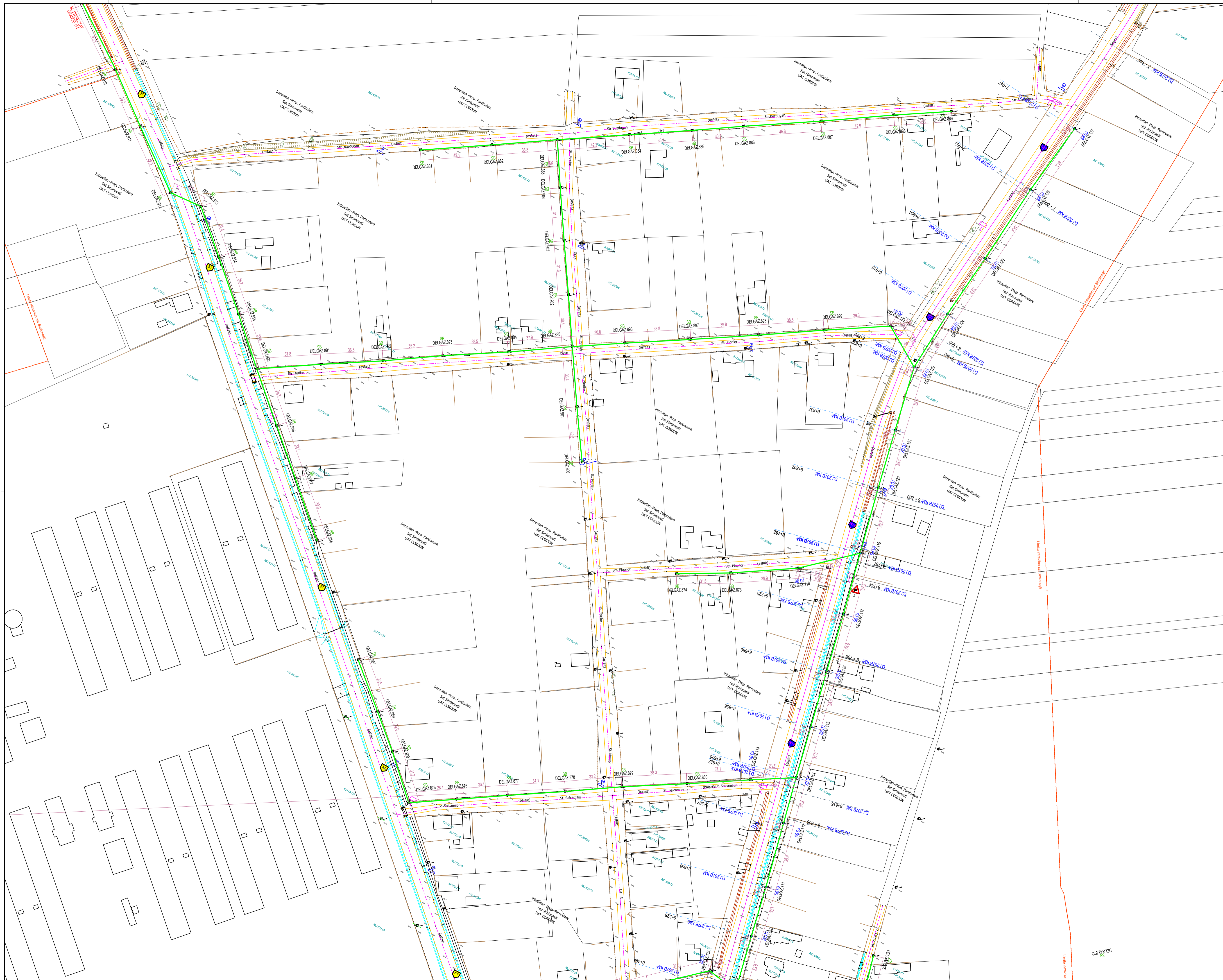

LEGENDA

LS	LUNGIME SANT 0.4 x 1.2 m
LT	LATIME TUB
1x10mm	NUMAR x DIAMETRU MONOTUB HOPE PROIECTAT
---	RETEA FO EXISTENTA MONTATA SUBTERAN
---	CANALIZATIE FO SUBTERANA EXISTENTA
---	CAMERETA EXISTENTA
---	INDICATIV NR. CAMERETA EXISTENTA
---	RETEA FO AERIANA PROIECTATA
---	RETEA FO MONTATA SUBTERAN PROIECTATA
DELGAZ 1	INDICATIV NR. STALP BETON EXISTENT IN ZONA DJ SI UAT
TELEKOM 1	INDICATIV NR. STALP LEMN EXISTENT IN ZONA DJ SI UAT
ORANGE 001	INDICATIV NR. STALP PROIECTAT ZONA DJ SI UAT
SL	INDICATIV TIP STALP LEMN EXISTENT UAT
SB	INDICATIV TIP STALP BETON EXISTENT UAT
SC DJ PROIECTAT	INDICATIV TIP STALP COMPOSIT PROIECTAT DJ
SC PROIECTAT	INDICATIV TIP STALP COMPOSIT PROIECTAT UAT
SL DJ	INDICATIV TIP STALP LEMN EXISTENT DJ
SB DJ	INDICATIV TIP STALP BETON EXISTENT DJ
---	STALPI PROIECTATI
---	STALPI EXISTENTI
---	AX DRUM
---	MARGINE DRUM
---	LIMITA PROPRIETATE
---	LIMITA UNITATE ADMINISTRATIV TERITORIALA
---	LIMITA INTRAVILAN

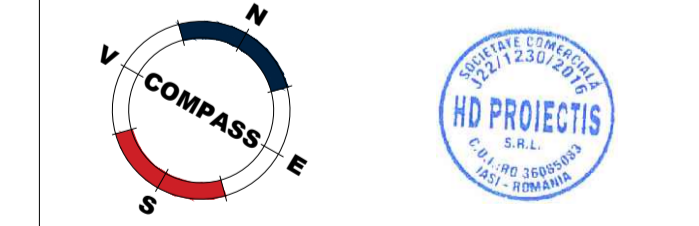

Verificator / Expert	NUME	SEMNATURA	CERINTA
NR. V.566	ING ROTARESCU A. IOAN		A1, A2
REFERAT/EXPERTIZA NR./DATA			
NR. _____ din _____			
PROIECTANT: S.C. HD PROIECTIS S.R.L. Sediul societății: Bld. Carol I, Nr.4, Clădirea Habitat Protect, Corp A, Etaj 2, Cam. 205-206, IASI CUI: 205-206, IASI J22/1230/2016 - R036085083			
SPECIFICATIE	NUME	SEMNATURA	SCARA
SEF PROIECT	ING. PRISACARU ANDREI		1:1000
PROIECTAT	ING. ALUCULESEI C.		DATA:
VERIFICAT	ING. CHRISLA IONUT		12.2021
DESEINAT	ARB. LORIN MARTINEC		
orange	ORANGE ROMANIA S.A. B-dul Lascar Catargiu, nr. 47-53, Europe House, sector 1, Bucuresti CUI: 9010105, 340/10178/1996		PROIECT NR.: 93 2021
TITLU PROIECT: INSTALARE TRASEU FIBRA OPTICA SUBTERAN SI AERIAN (RETEA FTTH PE STALPI) DELGAZ GRID S.A. SI NOI PROIECTATI, IN COMUNA CORDUN, JUDETLUL NEAMT			Faza: D.T.A.C. P.TH.+D.E.
DENUMIRE PLANSA: PLAN DE SITUATIE CU LUCRARI PROIECTATE IN SAT SIMIONEST, UAT CORDUN, JUDE NEAMT			PLANSĂ NR. T13
FORMAT PLANSA: 841mm x 594mm			

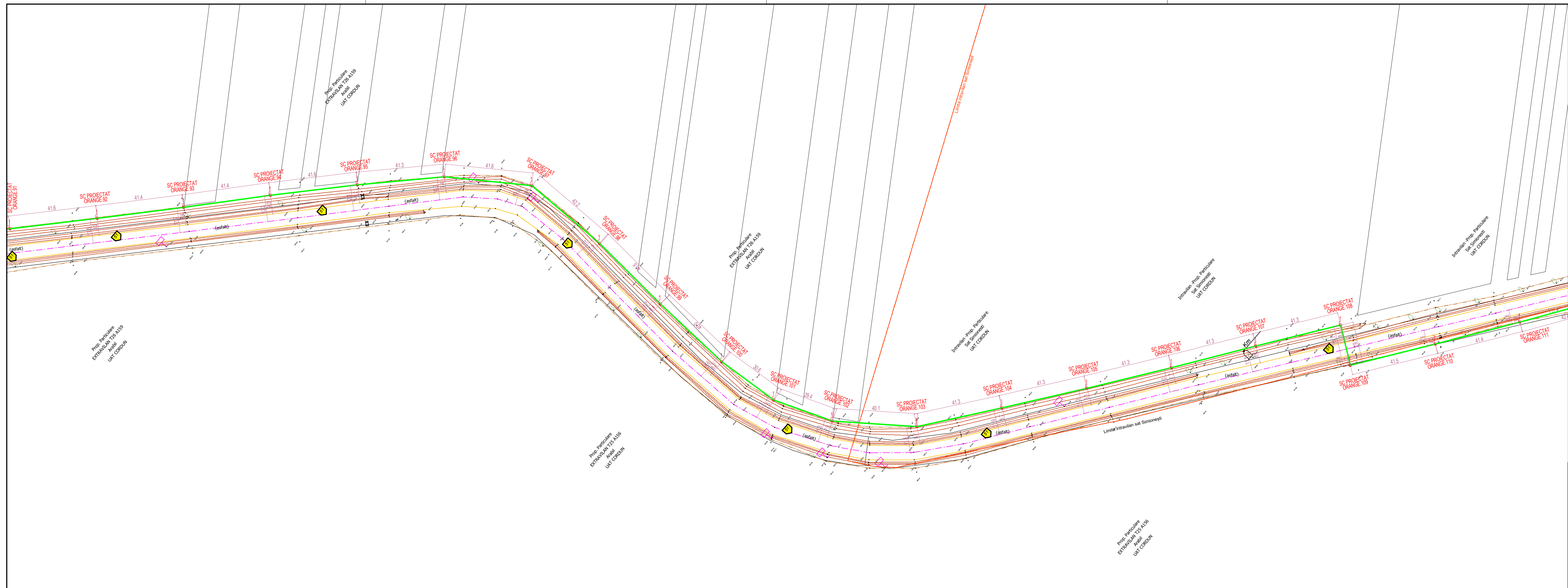

LEGENDA	
LS.	LUNGIME SANT 0.4 x 1.2 m
LT.	LATIME TUB
1x40mm	NUMAR x DIAMETRU MONOTUB HDPE PROIECTAT
—	RETEA FO EXISTENTA MONTATA SUBTERAN
—	CANALIZATIE FO SUBTERANA EXISTENTA
■	CAMERETA EXISTENTA
EXISTENTA	INDICATIV NR. CAMERETA EXISTENTA
—	RETEA FO AERIANA PROIECTATA
—	RETEA FO MONTATA SUBTERAN PROIECTATA
DELGAZ.1	INDICATIV NR. STALP BETON EXISTENT IN ZONA DJ SI UAT
TELEKOM.1	INDICATIV NR. STALP LEMN EXISTENT IN ZONA DJ SI UAT
ORANGE.001	INDICATIV NR. STALP PROIECTAT ZONA DJ SI UAT
SL	INDICATIV TIP STALP LEMN EXISTENT UAT
SB	INDICATIV TIP STALP BETON EXISTENT UAT
SC DJ PROIECTAT	INDICATIV TIP STALP COMPOSIT PROIECTAT DJ
SC PROIECTAT	INDICATIV TIP STALP COMPOSIT PROIECTAT UAT
SL DJ	INDICATIV TIP STALP LEMN EXISTENT DJ
SB DJ	INDICATIV TIP STALP BETON EXISTENT DJ
●	STALPI PROIECTATI
●	STALPI EXISTENTI
—	AX DRUM
—	MARGINE DRUM
—	LIMITA PROPRIETATE
—	LIMITA UNITATE ADMINISTRATIV TERITORIALA
—	LIMITA INTRAVILAN

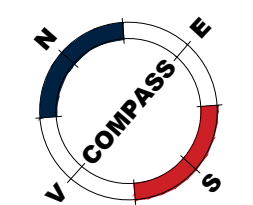

Verificator / Expert	NUME	SEMNRATURA	CERINTA	REFERAT/EXPERTIZA NR./DATA
NR. V.566	ING ROTARESCU A. IOAN		A1, A2	
PROIECTANT:	S.C. HD PROIECTIS S.R.L. Sediul social: Bld. Carol I, Nr.4, Cladirea Habitat Project, Corp A, Etaj 2, Cam. 205-206, IASI J22/1230/2016 - R036085083			ORANGE ROMANIA S.A. B-dul Lascar Catargiu, nr. 47-53, Europe House, sector 1, Bucuresti CUI: 9010105, J40/10178/1996
			FORMAT PLANSĂ: 297 x 950 mm	PROJECT NR.: 93 2021
SPECIFICATIE	NUME	SEMNRATURA	SCARA:	TITLU PROIECT:
SEF PROIECT	ING. PRISACARU ANDREI		1:1000	INSTALARE TRASEU FIBRA OPTICA SUBTERAN SI AERIAN (RETEA FTTH) PE STALPII DELGAZ GRID S.A. SI NOI PROIECTATI, IN COMUNA CORDUN, JUDETUL NEAMT
PROIECTAT	ING. ALIUCULESEI C.		DATA:	Faza: D.T.A.C. + P.TH.+D.E.
VERIFICAT	ING. CHIRILA IONUT		12.2021	DENUMIRE PLANSĂ: PLAN DE SITUATIE CU LUCRARI PROIECTATE IN SAT SIMONESTI, UAT CORDUN, JUD. NEAMT
DESENAT	ARH. LORIN MARTINIUC			PLANSĂ NR.: T14

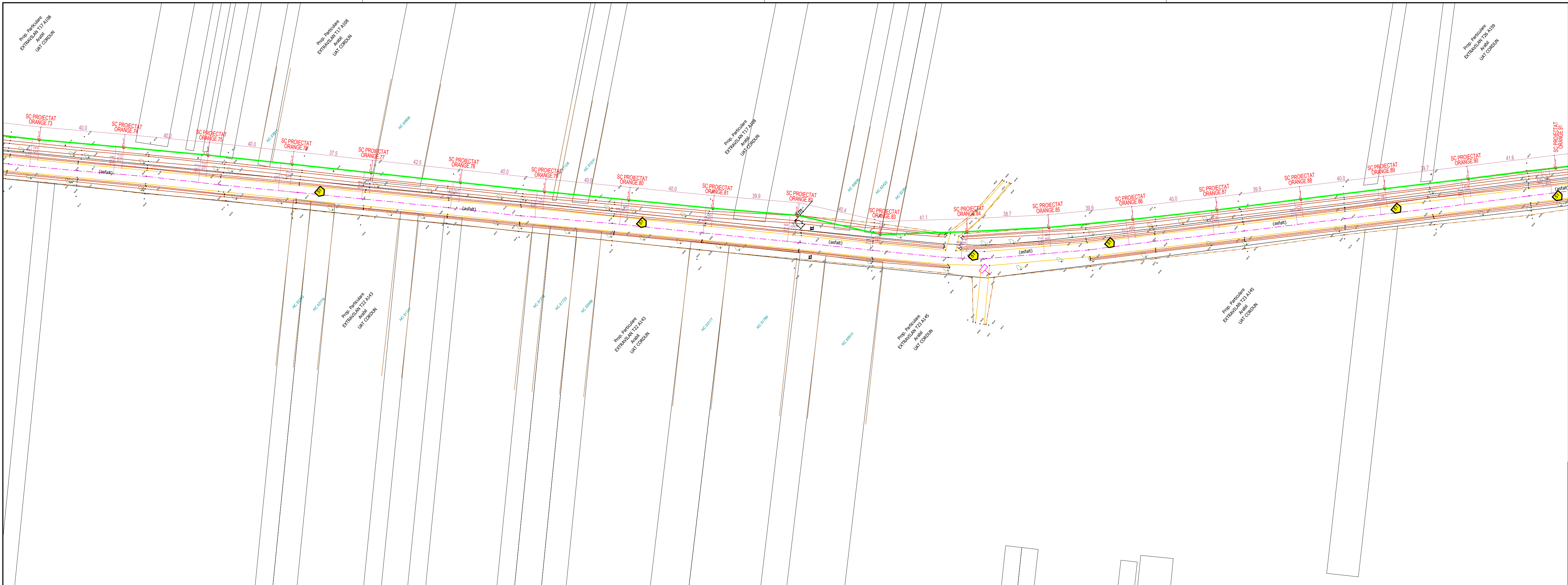

LEGENDA	
LS:	LUNGIME SANT 0.4 x 1.2 m
LT:	LATIME TUB
1x40mm	NUMAR x DIAMETRU MONOTUB HDPE PROIECTAT
	RETEA FO EXISTENTA MONTATA SUBTERAN
	CANALIZATIE FO SUBTERANA EXISTENTA
	CAMERETA EXISTENTA
	EXISTENTA
	INDICATIV NR. CAMERETA EXISTENTA
	RETEA FO AERIANA PROIECTATA
	RETEA FO MONTATA SUBTERAN PROIECTATA
DELGAZ1	INDICATIV NR. STALP BETON EXISTENT IN ZONA DJ SI UAT
TELEKOM.1	INDICATIV NR. STALP LEMN EXISTENT IN ZONA DJ SI UAT
ORANGE.001	INDICATIV NR. STALP PROIECTAT ZONA DJ SI UAT
SL	INDICATIV TIP STALP LEMN EXISTENT UAT
SB	INDICATIV TIP STALP BETON EXISTENT UAT
SC DJ PROIECTAT	INDICATIV TIP STALP COMPOSIT PROIECTAT DJ
SC PROIECTAT	INDICATIV TIP STALP COMPOSIT PROIECTAT UAT
SL DJ	INDICATIV TIP STALP LEMN EXISTENT DJ
SB DJ	INDICATIV TIP STALP BETON EXISTENT DJ
	STALPI PROIECTATI
	STALPI EXISTENTI
	AX DRUM
	MARGINE DRUM
	LIMITA PROPRIETATE
	LIMITA UNITATE ADMINISTRATIV TERITORIALA
	LIMITA INTRAVILAN

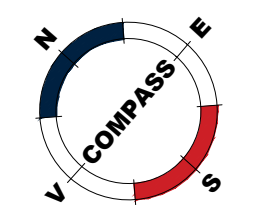

Verificator / Expert NR. V.566	NUME ING ROTARESCU A. IOAN	SEMNATURA	CERINTA A1, A2	REFERAT/EXPERTIZA NR./DATA
S.C. HD PROIECTIS S.R.L. Sediul social: Bld. Carol I, Nr.4, Cladirea Habitat Project, Corp A, Etaj 2, Cam. 205-206, IASI J22/1230/2016 - RO36085083			ORANGE ROMANIA S.A. B-dul Lascar Catargiu, nr. 47-53, Europe House, sector 1, Bucuresti CUI: 9010105, J40/10178/1996	PROIECT NR.: 93 2021
FORMAT PLANSĂ: 297 x 950 mm				TITLU PROIECT: INSTALARE TRASEU FIBRA OPTICA SUBTERAN SI AERIAN (RETEA FTTH) PE STALPII DELGAZ GRID S.A. SI NOI PROIECTATI, IN COMUNA CORDUN, JUDETUL NEAMT
SPECIFICATIE SEF PROIECT PROIECTAT VERIFICAT DESENAT	NUME ING. PRISACARU ANDREI ING. ALIUCULESEI C. ING. CHIRILA IONUT ARH. LORIN MARTINIUC	SEMNATURA 	SCARA: 1:1000 DATA: 12.2021	Faza: D.T.A.C. + P.TH.+D.E. PLANSĂ NR.: T15
DENUMIRE PLANSĂ: PLAN DE SITUATIE CU LUCRARI PROIECTATE IN UAT CORDUN, JUD. NEAMT				

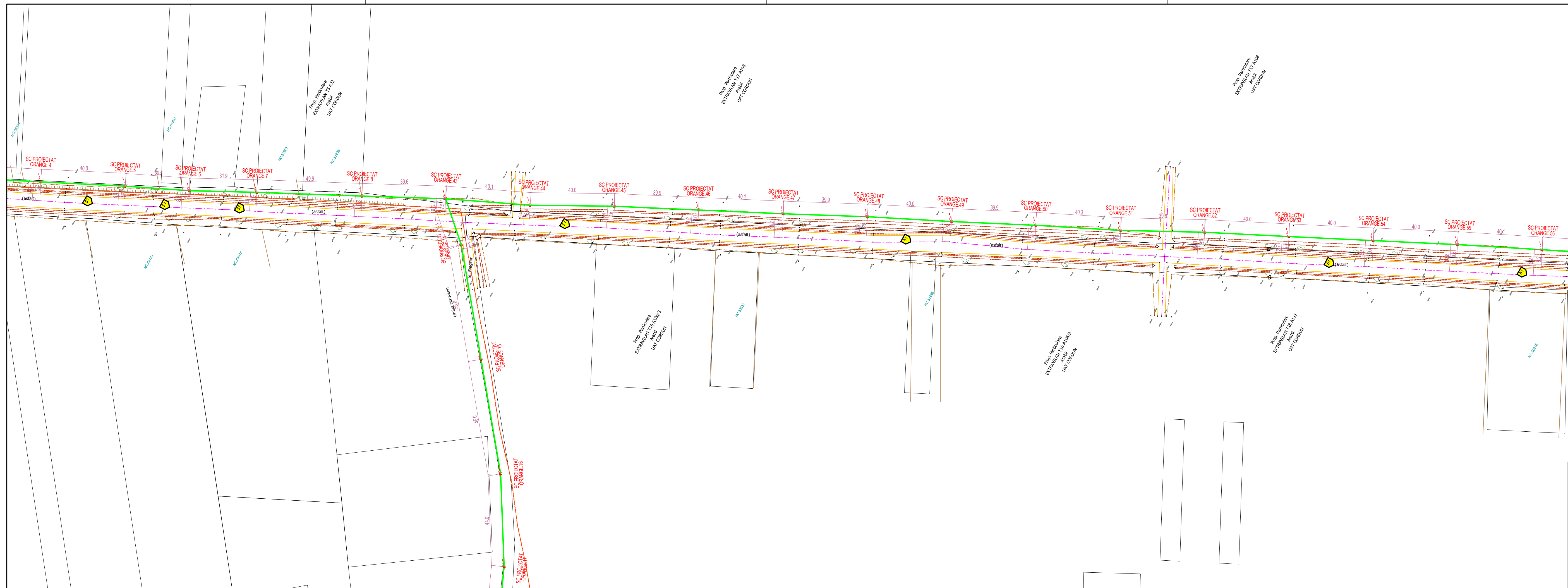

LEGENDA	
LS:	LUNGIME SANT 0.4 x 1.2 m
LT:	LATIME TUB
1x40mm	NUMAR x DIAMETRU MONOTUB HDPE PROIECTAT
	RETEA FO EXISTENTA MONTATA SUBTERAN
	CANALIZATIE FO SUBTERANA EXISTENTA
	CAMERETA EXISTENTA
	EXISTENTA
	RETEA FO AERIANA EXISTENTA
	RETEA FO MONTATA SUBTERAN PROIECTATA
DELGAZ.1	INDICATIV NR. STALP BETON EXISTENT IN ZONA DJ SI UAT
TELEKOM.1	INDICATIV NR. STALP LEMN EXISTENT IN ZONA DJ SI UAT
ORANGE.001	INDICATIV NR. STALP LEMN EXISTENT IN ZONA DJ SI UAT
SL	INDICATIV TIP STALP LEMN EXISTENT UAT
SB	INDICATIV TIP STALP BETON EXISTENT UAT
SC DJ PROIECTAT	INDICATIV TIP STALP COMPOSIT PROIECTAT DJ
SC PROIECTAT	INDICATIV TIP STALP COMPOSIT PROIECTAT UAT
SL DJ	INDICATIV TIP STALP LEMN EXISTENT DJ
SB DJ	INDICATIV TIP STALP BETON EXISTENT DJ
	STALPI PROIECTATI
	STALPI EXISTENTI
	AX DRUM
	MARGINE DRUM
	LIMITA PROPRIETATE
	LIMITA UNITATE ADMINISTRATIV TERITORIALA
	LIMITA INTRAVILAN

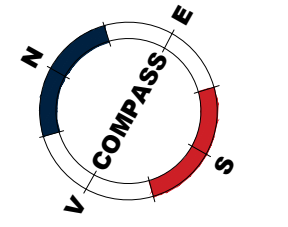

Verificator / Expert	NUME	SEMNTURA	CERINTA	REFERAT/EXPERTIZA NR./DATA
NR. V.566	ING ROTARESCU A. IOAN		A1, A2	
PROIECTANT:	S.C. HD PROIECTIS S.R.L. Sediu social: Bld. Carol I, Nr.4, Cladirea Habitat Project, Corp A, Etaj 2, Cam. 205-206, IASI J22/1230/2016 - R036085083			PROIECT NR.: 93
				ORANGE ROMANIA S.A. B-dul Lascar Catargiu, nr. 47-53, Europe House, sector 1, Bucuresti CUI: 9010105, J40/10178/1996
	FORMAT PLANSA: 297 x 950 mm			TITLU PROIECT: INSTALARE TRASEU FIBRA OPTICA SUBTERAN SI AERIAN (RETEA FTTH) PE STALPII DELGAZ GRID S.A. SI NOI PROIECTATI, IN COMUNA CORDUN, JUDETUL NEAMT
SPECIFICATIE	NUME	SEMNTURA	SCARA:	Faza: D.T.A.C. + P.TH.+D.E.
SEF PROIECT	ING. PRISACARU ANDREI		1:1000	
PROIECTAT	ING. ALIUCULESEI C.		DATA:	
VERIFICAT	ING. CHIRILA IONUT		12.2021	
DESENAT	ARH. LORIN MARTINIUC			PLANSA NR.: T17
	DENUMIRE PLANSA: PLAN DE SITUATIE CU LUCRARI PROIECTATE IN SAT PILDESTI, UAT CORDUN, JUD. NEAMT			

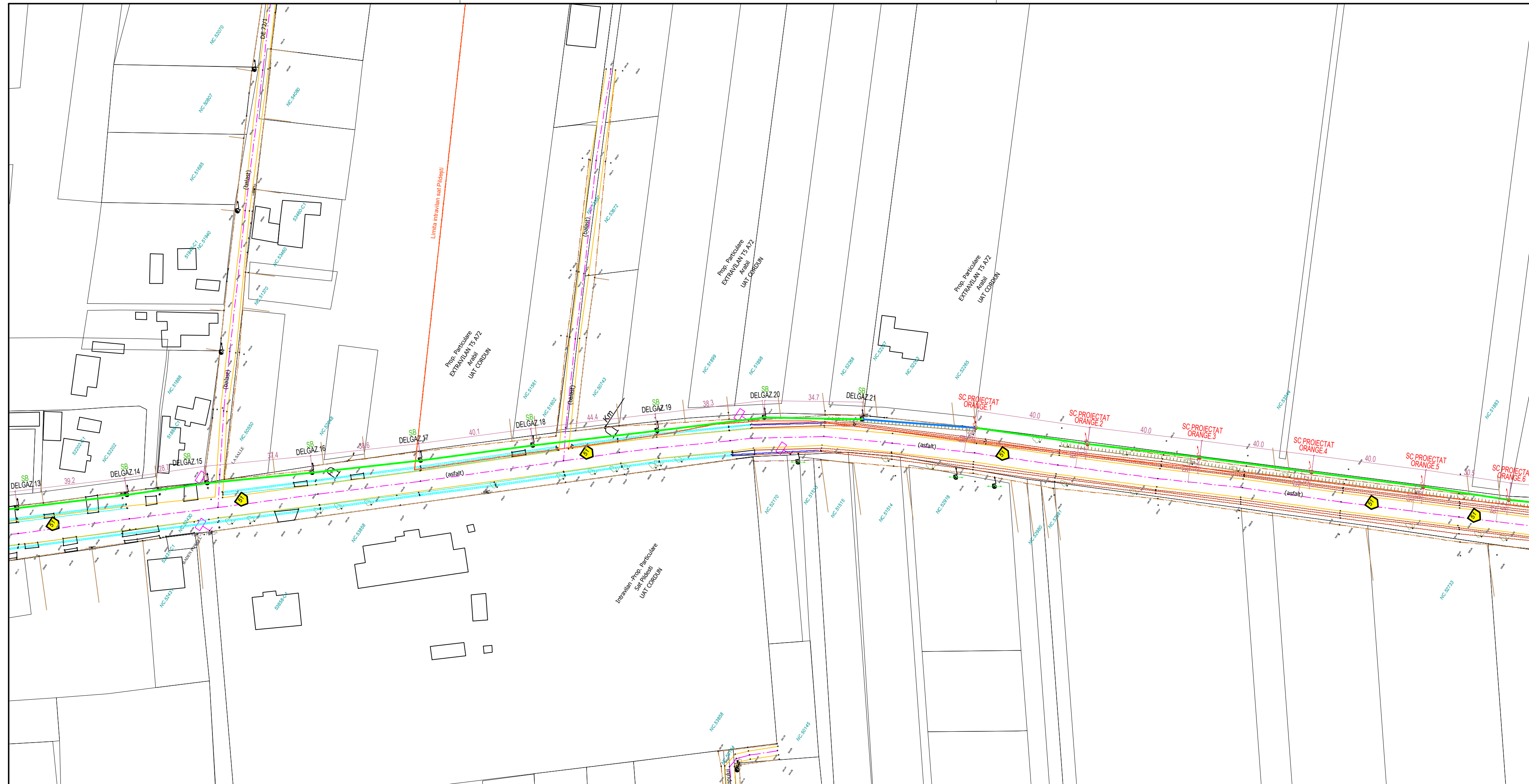

LEGENDA	
LS:	LUNGIME SANT 0.4 x 1.2 m
LT:	LATIME TUB
1x40mm	NUMAR x DIAMETRU MONOTUB HDPE PROIECTAT
	RETEA FO EXISTENTA MONTATA SUBTERAN
	CANALIZATIE FO SUBTERANA EXISTENTA
	CAMERETA EXISTENTA
EXISTENTA	INDICATIV NR. CAMERETA EXISTENTA
	RETEA FO AERIANA PROIECTATA
	RETEA FO MONTATA SUBTERAN PROIECTATA
DELGAZ.1	INDICATIV NR. STALP BETON EXISTENT IN ZONA DJ SI UAT
TELEKOM.1	INDICATIV NR. STALP LEMN EXISTENT IN ZONA DJ SI UAT
ORANGE.001	INDICATIV NR. STALP PROIECTAT ZONA DJ SI UAT
SL	INDICATIV TIP STALP LEMN EXISTENT UAT
SB	INDICATIV TIP STALP BETON EXISTENT UAT
SC DJ PROIECTAT	INDICATIV TIP STALP COMPOSIT PROIECTAT DJ
SC PROIECTAT	INDICATIV TIP STALP COMPOSIT PROIECTAT UAT
SL DJ	INDICATIV TIP STALP LEMN EXISTENT DJ
SB DJ	INDICATIV TIP STALP BETON EXISTENT DJ
	STALPI PROIECTATI
	STALPI EXISTENTI
	AX DRUM
	MARGINE DRUM
	LIMITA PROPRIETATE
	LIMITA UNITATE ADMINISTRATIV TERITORIALA
	LIMITA INTRAVILAN

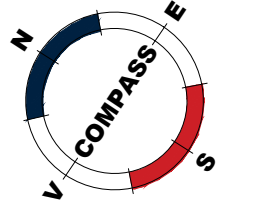

Verificator / Expert	NUME	SEMNTATURA	CERINTA	REFERAT/EXPERTIZA NR./DATA
NR. V.566	ING ROTARESCU A. IOAN		A1, A2	
PROIECTANT:	S.C. HD PROIECTIS S.R.L. Sediu social: Bld. Carol I, Nr.4, Cladirea Habitat Project, Corp A, Etaj 2, Cam. 205-206, IASI 122/1230/2016 - RO36085083			ORANGE ROMANIA S.A. B-dul Lascar Catargiu, nr. 47-53, Europe House, sector 1, Bucuresti CUI: 9010105, 340/10178/1996
FORMAT PLANSA: 297 x 750 mm				PROIECT NR.: 93 2021
SPECIFICATIE NUME SEMNTATURA SCARA:				Faza: D.T.A.C. + P.T.H.+D.E. PLANSA NR.: T18
SEF PROIECT	ING. PRISACARU ANDREI		1:1000	
PROIECTAT	ING. ALUCULESEI C.		DATA:	
VERIFICAT	ING. CHIRILA IONUT		12.2021	
DESENAT	ARH. LORIN MARTINIUC			TITLU PROIECT: INSTALARE TRASEU FIBRA OPTICA SUBTERAN SI AERIAN (RETEA FTTH) PE STALPII DELGAZ GRID S.A. SI NOI PROIECTATI, IN COMUNA CORDUN, JUDETUL NEAMT

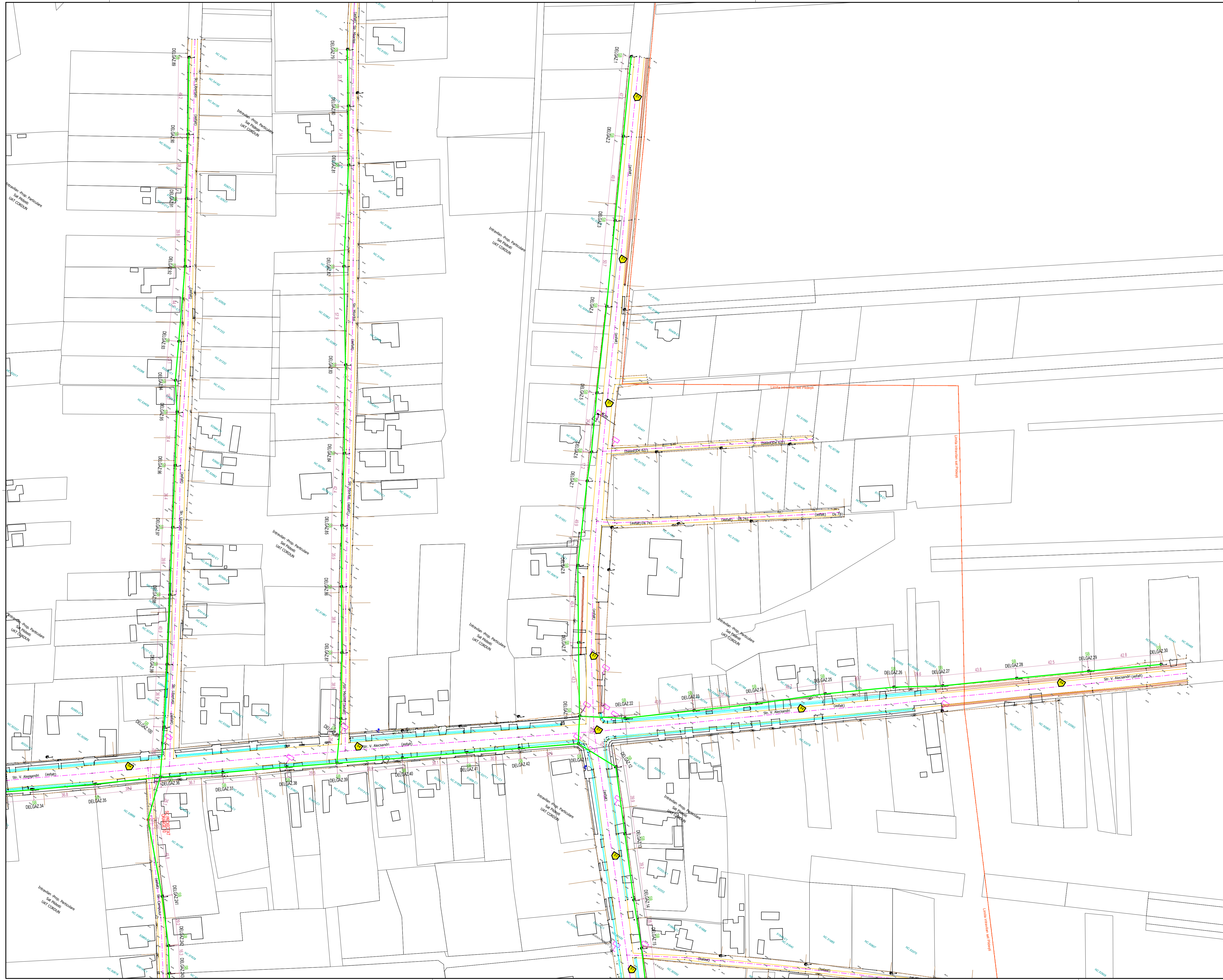

LEGENDA

LS	LUNGIME SANT 0.4 x 1.2 m
LT	LATIME TUB
1x10mm	NUMAR x DIAMETRU MONOTUB HOPE PROIECTAT
---	RETEA FO EXISTENTA MONTATA SUBTERAN
---	CANALIZATIE FO SUBTERANA EXISTENTA
---	CAMERETA EXISTENTA
---	INDICATIV NR. CAMERETA EXISTENTA
---	RETEA FO AERIANA PROIECTATA
---	RETEA FO MONTATA SUBTERAN PROIECTATA
DELGAZ 1	INDICATIV NR. STALP BETON EXISTENT IN ZONA DJ SI UAT
TELEKOM 1	INDICATIV NR. STALP LEMN EXISTENT IN ZONA DJ SI UAT
ORANGE 001	INDICATIV NR. STALP PROIECTAT ZONA DJ SI UAT
SL	INDICATIV TIP STALP LEMN EXISTENT UAT
SB	INDICATIV TIP STALP BETON EXISTENT UAT
SC DJ PROIECTAT	INDICATIV TIP STALP COMPOSIT PROIECTAT DJ
SC PROIECTAT	INDICATIV TIP STALP COMPOSIT PROIECTAT UAT
SL DJ	INDICATIV TIP STALP LEMN EXISTENT DJ
SB DJ	INDICATIV TIP STALP BETON EXISTENT DJ
---	STALPI PROIECTATI
---	STALPI EXISTENTI
---	AX DRUM
---	MARGINE DRUM
---	LIMITA PROPRIETATE
---	LIMITA LUNITATE ADMINISTRATIV TERITORIALA
---	LIMITA INTRAVILAN

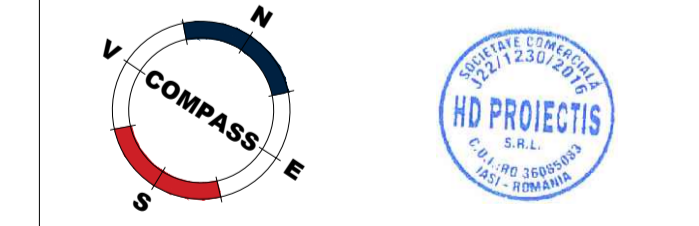

Verificator / Expert	NUME	SEMNATURA	CERINTA
NR. V.566	ING. ROTARESCU A. IOAN		A1, A2
REFERAT/EXPERTIZA NR./DATA			
NR. _____ din _____			
PROIECTANT: S.C. HD PROIECTIS S.R.L. Sediul societati: Bld. Carol I, Nr.4, Cladirea Habitat Proiect, Corp A, Etaj 2. Cam. 205-206, IASI J22/1230/2016 - RO36085083			
SPECIFICATIE	NUME	SEMNATURA	SCARA
SEF PROIECT	ING. PRISACARU ANDREI		1:1000
PROIECTAT	ING. ALUCULESEI C.		DATA:
VERIFICAT	ING. CHRISLA IONUT		12.2021
DESEINAT	ARB. LORIN MARTINEUC		
orange	ORANGE ROMANIA S.A. B-dul Lascar Catargiu, nr. 47-53, Europe House, sector 1, Bucuresti CUI: 9010105, J40/10178/1996		PROIECT NR.: 93 2021
TITLU PROIECT: INSTALARE TRASEU FIBRA OPTICA SUBTERAN SI AERIAN (RETEA FTTH PE STALPI DELGAZ GRID S.A. SI NOI PROIECTATI, IN COMUNA CORDUN, JUDETUL NEAMT)			Faza: D.T.A.C. P.TH.+D.E.
DENUMIRE PLANSA: PLAN DE SITUATIE CU LUCRARI PROIECTATE IN SAT PILDESTI, UAT CORDUN, JUD. NEAMT			PLANSA NR. T19
FORMAT PLANSA: 841mm x 594mm			



Înch. Proiectare
 27/07/2016 în 1:1000
 UAT CORDUN

LEGENDA

LS	LUNGIME SANT 0.4 x 1.2 m
LT	LATIME TUB
1x40mm	NUMAR x DIAMETRU MONOTUB HOPE PROIECTAT
(Orange line)	RETEA FO EXISTENTA MONTATA SUBTERAN
(Blue line)	CANALIZATIE FO SUBTERANA EXISTENTA
(Green line)	CAMERETA EXISTENTA
(Light green line)	INDICATIV NR. CAMERETA EXISTENTA
(Light blue line)	RETEA FO AERIANA PROIECTATA
(Light green line)	RETEA FO MONTATA SUBTERAN PROIECTATA
DELGAZ 1	INDICATIV NR. STALP BETON EXISTENT IN ZONA DJ SI UAT
TELEKOM 1	INDICATIV NR. STALP LEMN EXISTENT IN ZONA DJ SI UAT
ORANGE 001	INDICATIV NR. STALP PROIECTAT ZONA DJ SI UAT
SL	INDICATIV TIP STALP LEMN EXISTENT UAT
SB	INDICATIV TIP STALP BETON EXISTENT UAT
SC DJ PROIECTAT	INDICATIV TIP STALP COMPOSIT PROIECTAT DJ
SC PROIECTAT	INDICATIV TIP STALP COMPOSIT PROIECTAT UAT
SL DJ	INDICATIV TIP STALP LEMN EXISTENT DJ
SB DJ	INDICATIV TIP STALP BETON EXISTENT DJ
(Red circle)	STALPI PROIECTATI
(Red circle)	STALPI EXISTENTI
(Dashed line)	AX DRUM
(Dashed line)	MARGINE DRUM
(Dashed line)	LIMITA PROPRIETATE
(Dashed line)	LIMITA UNITATE ADMINISTRATIV TERITORIALA
(Dashed line)	LIMITA INTRAVILAN

Verificator / Expert	NUME	SEMNATURA	CERINTA
NR. V.566	ING ROTARESCU A. IOAN		A1, A2
REFERAT/EXPERTIZA NR./DATA			
NR. _____ din _____			
PROIECTANT: S.C. HD PROIECTIS S.R.L. Sediul societati: Blvd. Carol I, Nr.4, Cladirea Habitat Project, Corp A, Etaj 2, Cam. 205-206, IASI J22/1230/2016 - R036085083			
SPECIFICATIE	NUME	SEMNATURA	SCARA:
SEF PROIECT	ING. PRISACARU ANDREI		1:1000
PROIECTAT	ING. ALUCULESEI C.		DATA:
VERIFICAT	ING. CHERILA IONUT		12.2021
DESEINAT	ARH. LORIN MARTINEUC		
orange	ORANGE ROMANIA S.A. B-dul Lascar Catargiu, nr. 47-53, Europe House, sector 1, Bucuresti CUI: 9010105, J40/10178/1996		PROIECT NR.: 93 2021
TITLU PROIECT: INSTALARE TRASEU FIBRA OPTICA SUBTERAN SI AERIAN (RETEA FTTH PE STALPI) DELGAZ GRID S.A. SI NOI PROIECTATI, IN COMUNA CORDUN, JUDETUL NEAMT			Faza: D.T.A.C. P.TH.+D.E.
DENUMIRE PLANSA: PLAN DE SITUATIE CU LUCRARI PROIECTATE IN SAT PILDESTI, UAT CORDUN, JUD. NEAMT			PLANSA NR.: T20
FORMAT PLANSA: 841mm x 594mm			

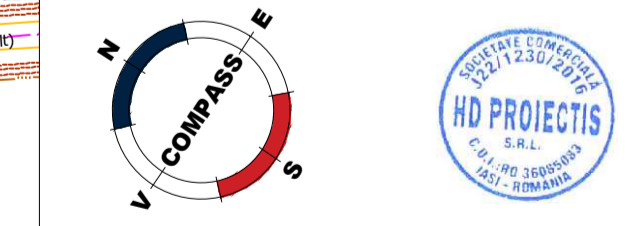



LEGENDA

LS	LUNGIME SANT 0.4 x 1.2 m
LT	LATIME TUB
140mm	NUMAR x DIAMETRU MONOTUB HOPE PROIECTAT
---	RETEA FO EXISTENTA MONTATA SUBTERAN
---	CANALIZATIE FO SUBTERANA EXISTENTA
---	CAMERETA EXISTENTA
---	RETEA FO AERIANA EXISTENTA
---	RETEA FO MONTATA SUBTERAN PROIECTATA
DELGAZ 1	INDICATIV NR. STALP BETON EXISTENT IN ZONA DJ SI UAT
TELEKOM 1	INDICATIV NR. STALP LEMN EXISTENT IN ZONA DJ SI UAT
ORANGE 001	INDICATIV NR. STALP PROIECTAT ZONA DJ SI UAT
SL	INDICATIV TIP STALP LEMN EXISTENT UAT
SB	INDICATIV TIP STALP BETON EXISTENT UAT
SC DJ PROIECTAT	INDICATIV TIP STALP COMPOSIT PROIECTAT DJ
SC PROIECTAT	INDICATIV TIP STALP COMPOSIT PROIECTAT UAT
SL DJ	INDICATIV TIP STALP LEMN EXISTENT DJ
SB DJ	INDICATIV TIP STALP BETON EXISTENT DJ
---	STALPI PROIECTATI
---	STALPI EXISTENTI
---	AX DRUM
---	MARGINE DRUM
---	LIMITA PROPRIETATE
---	LIMITA UNITATE ADMINISTRATIV TERITORIALA
---	LIMITA INTRAVILAN

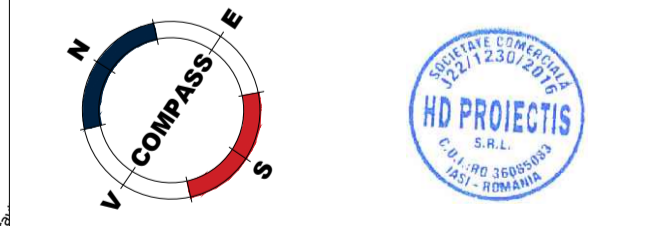

Verificator / Expert	NUME	SEMNATURA	CERINTA
NR. V.566	ING ROTARESCU A. IOAN		A1, A2
REFERAT/EXPERTIZA NR./DATA			
NR. _____ din _____			

PROIECTANT: **S.C. HD PROIECTIS S.R.L.**
 Sediul societati: Blvd. Carol I, Nr.4, Cladirea Habitat Protect, Corp A, Etaj 2, Cam. 205-206, IASI
122/1230/2016 - R036085083

SPECIFICATIE	NUME	SEMNATURA	SCARA:
SEF PROIECT	ING. PRISACARU ANDREI		1:1000
PROIECTAT	ING. ALUCULESEI C.		DATA:
VERIFICAT	ING. CHERILA IONUT		12.2021
DESEINAT	ARB. LORIN MARTINEUC		

ORANGE ROMANIA S.A.
 B-dul Lascar Catargiu, nr. 47-53, Europe House, sector 1, Bucuresti
 CUI: 9010105, 340/10178/1996

TITLU PROIECT:
 INSTALARE TRASEU FIBRA OPTICA SUBTERAN SI AERIAN (RETEA FTTH PE STALPI) DELGAZ GRID S.A. SI NOI PROIECTATI, IN COMUNA CORDUN, JUDETUL NEAMT

DENUMIRE PLANSA:
 PLAN DE SITUATIE
 CU LUCRARI PROIECTATE IN SAT PLEDESTI, UAT CORDUN, JUD. NEAMT

FORMAT PLANSA: 841mm x 594mm

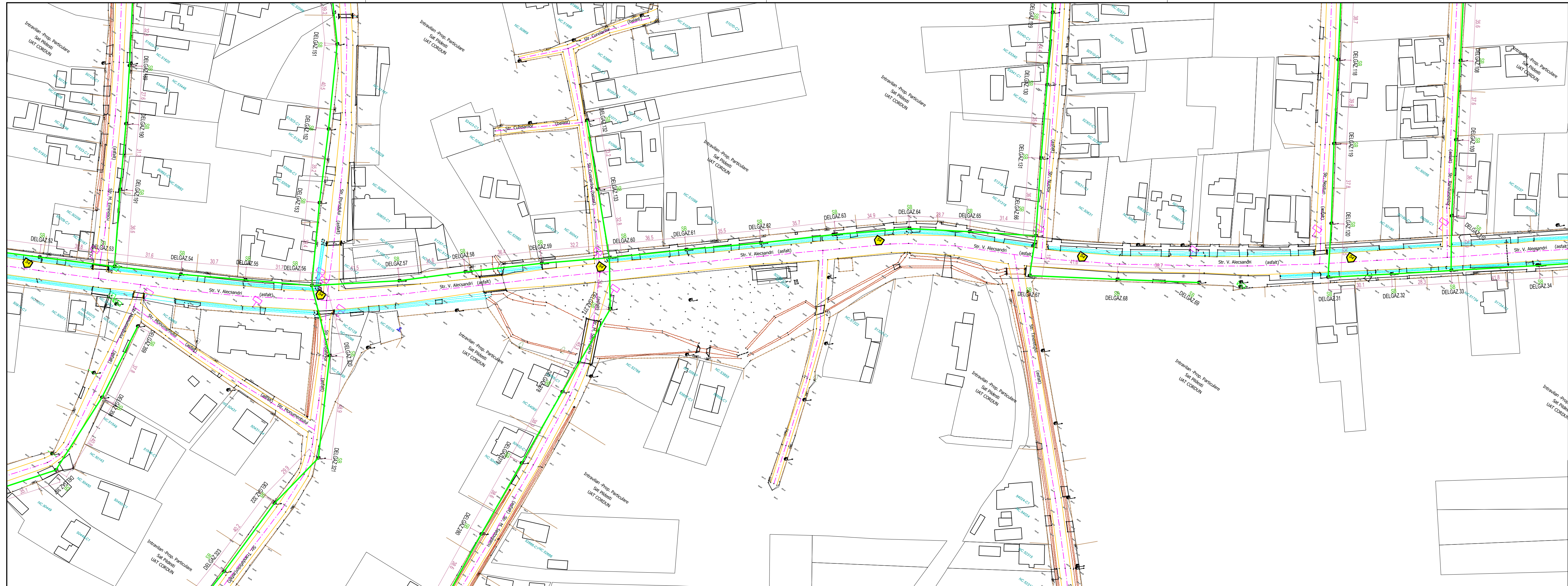

LEGENDA	
LS	LUNGIME SANT 0.4 x 1.2 m
LT	LATIME TUB
1x40mm	NUMAR x DIAMETRU MONOTUB HDPE PROIECTAT
—	RETEA FO EXISTENTA MONTATA SUBTERAN
—	CANALIZATIE FO SUBTERANA EXISTENTA
■	CAMERETA EXISTENTA
EXISTENTA	INDICATIV NR. CAMERETA EXISTENTA
—	RETEA FO AERIANA PROIECTATA
—	RETEA FO MONTATA SUBTERAN PROIECTATA
DELGAZ.1	INDICATIV NR. STALP BETON EXISTENT IN ZONA DJ SI UAT
TELEKOM.1	INDICATIV NR. STALP LEMN EXISTENT IN ZONA DJ SI UAT
ORANGE.001	INDICATIV NR. STALP PROIECTAT ZONA DJ SI UAT
SL	INDICATIV TIP STALP LEMN EXISTENT UAT
SB	INDICATIV TIP STALP BETON EXISTENT UAT
SC DJ PROIECTAT	INDICATIV TIP STALP COMPOSIT PROIECTAT DJ
SC PROIECTAT	INDICATIV TIP STALP COMPOSIT PROIECTAT UAT
SL DJ	INDICATIV TIP STALP LEMN EXISTENT DJ
SB DJ	INDICATIV TIP STALP BETON EXISTENT DJ
●	STALPI PROIECTATI
●	STALPI EXISTENTI
—	AX DRUM
—	MARGINE DRUM
—	LIMITA PROPRIETATE
—	LIMITA UNITATE ADMINISTRATIV TERITORIALA
—	LIMITA INTRAVILAN

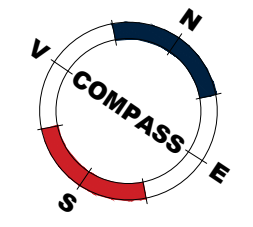

Verificator / Expert	NUME	SEMNTURA	CERINTA	REFERAT/EXPERTIZA NR./DATA
NR. V.566	ING ROTARESCU A. IOAN		A1, A2	
PROIECTANT:	S.C. HD PROIECTIS S.R.L. Sediul social: Bld. Carol I, Nr.4, Cladirea Habitat Project, Corp A, Etaj 2, Cam. 205-206, IASI J22/1230/2016 - RO36085083			PROIECT NR.:
				93
				2021
				Faza: D.T.A.C. + P.TH.+D.E.
				PLANSA NR.:
				T22

FORMAT PLANSA: 297 x 950 mm

SCARA: 1:1000

DATA: 12.2021

TITLU PROIECT:
INSTALARE TRASEU FIBRA OPTICA SUBTERAN SI AERIAN (RETEA FTTH) PE STALPII DELGAZ GRID S.A. SI NOI PROIECTATI, IN COMUNA CORDUN, JUDETUL NEAMT

DENUMIRE PLANSA:
 PLAN DE SITUATIE
 CU LUCRARI PROIECTATE IN SAT PILDESTI, UAT CORDUN, JUD. NEAMT

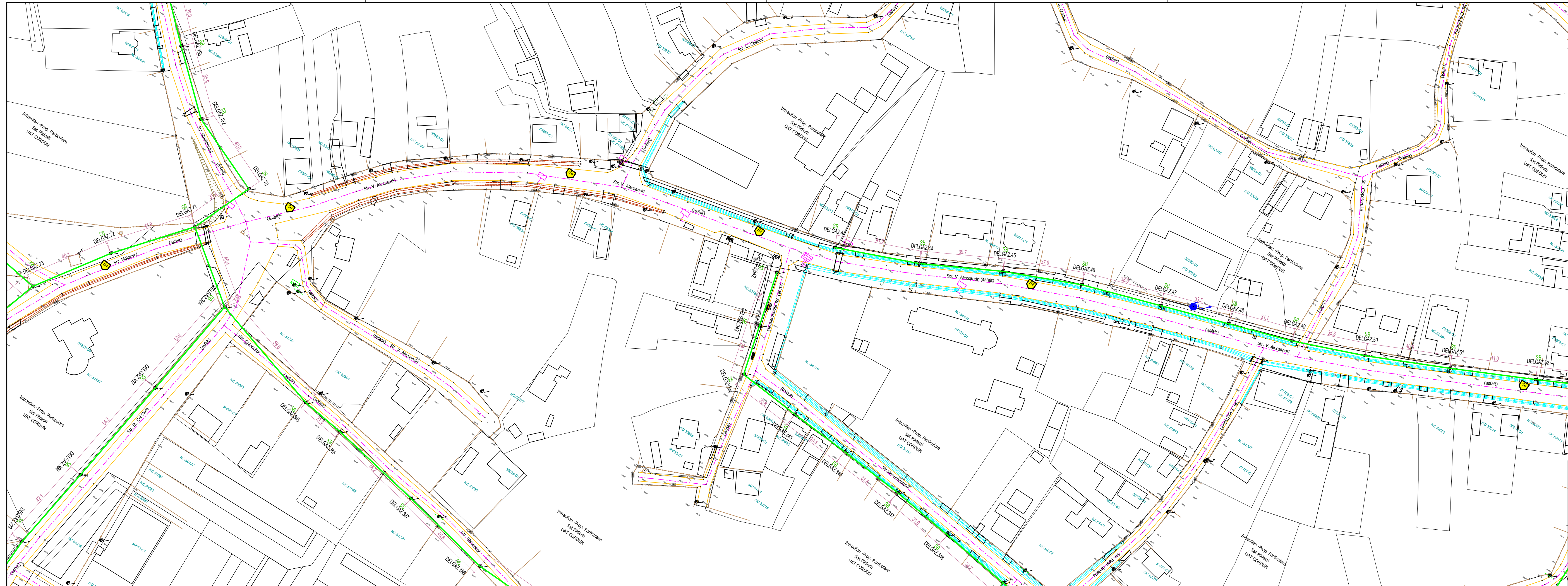

LEGENDA	
LS	LUNGIME SANT 0.4 x 1.2 m
LT	LATIME TUB
1x40mm	NUMAR x DIAMETRU MONOTUB HDPE PROIECTAT
—	RETEA FO EXISTENTA MONTATA SUBTERAN
—	CANALIZATIE FO SUBTERANA EXISTENTA
■	CAMERETA EXISTENTA
■	EXISTENTA
■	INDICATIV NR. CAMERETA EXISTENTA
■	RETEA FO AERIANA PROIECTATA
■	RETEA FO MONTATA SUBTERAN PROIECTATA
DELGAZ.1	INDICATIV NR. STALP BETON EXISTENT IN ZONA DJ SI UAT
DELGAZ.1	INDICATIV NR. STALP LEMN EXISTENT IN ZONA DJ SI UAT
ORANGE.001	INDICATIV NR. STALP PROIECTAT ZONA DJ SI UAT
SL	INDICATIV TIP STALP LEMN EXISTENT UAT
SB	INDICATIV TIP STALP BETON EXISTENT UAT
SC DJ PROIECTAT	INDICATIV TIP STALP COMPOSIT PROIECTAT DJ
SC PROIECTAT	INDICATIV TIP STALP COMPOSIT PROIECTAT UAT
SL DJ	INDICATIV TIP STALP LEMN EXISTENT DJ
SB DJ	INDICATIV TIP STALP BETON EXISTENT DJ
■	STALPI PROIECTATI
■	STALPI EXISTENTI
—	AX DRUM
—	MARGINE DRUM
—	LIMITA PROPRIETATE
—	LIMITA UNITATE ADMINISTRATIV TERITORIALA
—	LIMITA INTRAVILAN

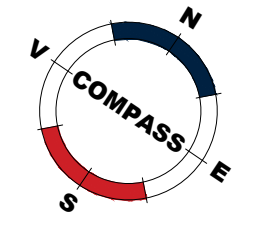

Verificator / Expert	NUME	SEMNTURA	CERINTA	REFERAT/EXPERTIZA NR./DATA	PROJECT NR.:
NR. V.566	ING ROTARESCU A. IOAN		A1, A2		93
PROIECTANT:	S.C. HD PROIECTIS S.R.L. Sediul social: Bld. Carol I, Nr.4, Cladirea Habitat Project, Corp A, Etaj 2, Cam. 205-206, IASI 122/1230/2016 - R036085083			ORANGE ROMANIA S.A. B-dul Lascau Catargiu, nr. 47-53, Europe House, sector 1, Bucuresti CUI: 9010105, J40/10178/1996	2021
FORMAT PLANSA: 297 x 950 mm				TITLU PROIECT:	Faza:
				INSTALARE TRASEU FIBRA OPTICA SUBTERAN SI AERIAN (RETEA FTTH) PE STALPII DELGAZ GRID S.A. SI NOI PROIECTATI, IN COMUNA CORDUN, JUDETUL NEAMT	D.T.A.C. + P.TH.+D.E.
SPECIFICATIE	NUME	SEMNTURA	SCARA:	DENUMIRE PLANSA:	PLANSA NR.:
SEF PROIECT	ING. PRISACARU ANDREI		1:1000	PLAN DE SITUATIE	T23
PROIECTAT	ING. ALIUCULESEI C.		DATA:	CU LUCRARI PROIECTATE IN SAT PILDESTI, UAT CORDUN, JUD. NEAMT	
VERIFICAT	ING. CHRILIA IONUT		12.2021		
DESENAT	ARH. LORIN MARTINIUC				

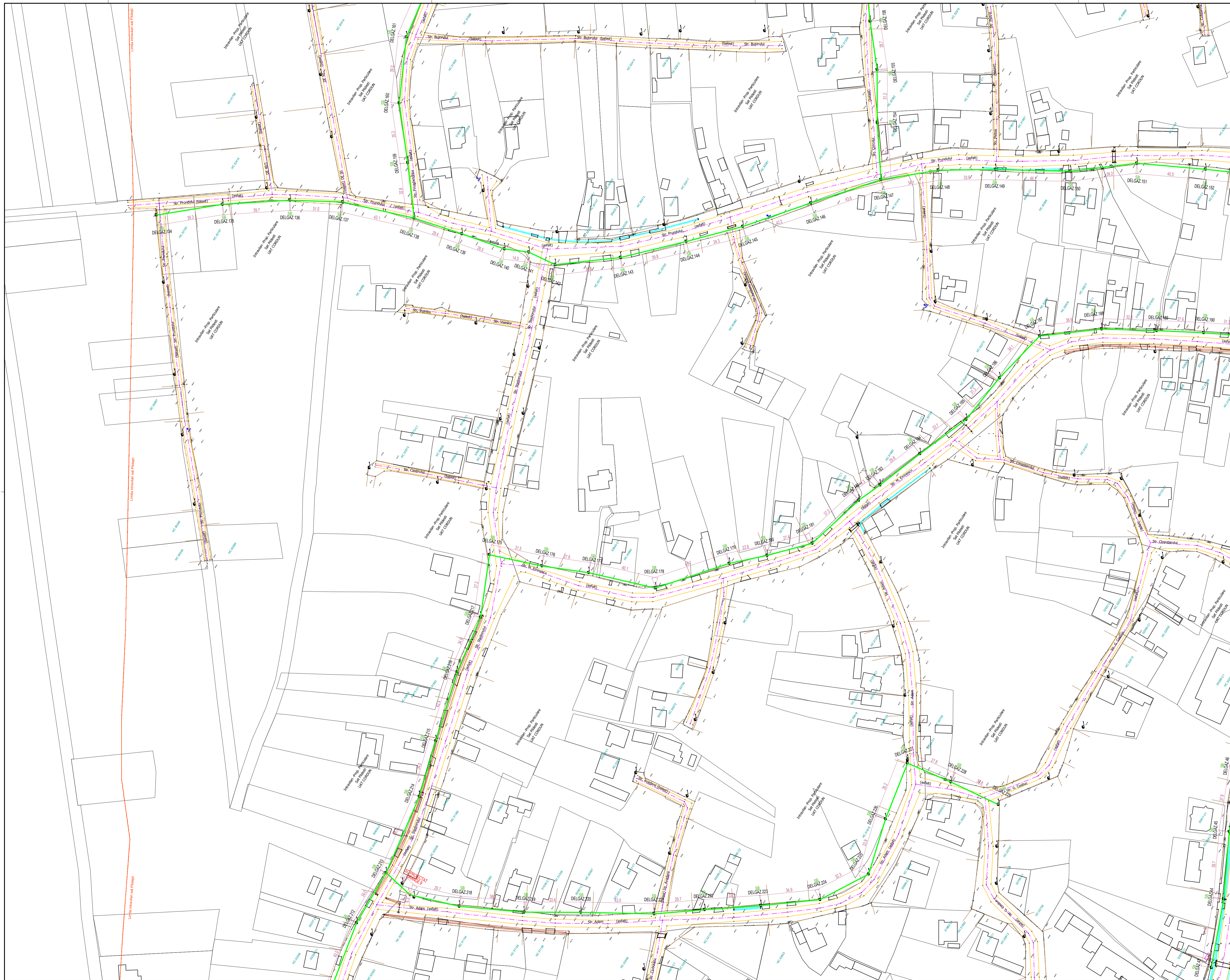

LEGENDA

LS	LUNGIME SANT 0.4 x 1.2 m
LT	LATIME TUB
140mm	NUMAR x DIAMETRU MONOTUB HOPE PROIECTAT
(Orange line)	RETEA FO EXISTENTA MONTATA SUBTERAN
(Blue line)	CANALIZATIE FO SUBTERANA EXISTENTA
(Green line)	CAMERETA EXISTENTA
(Light blue line)	INDICATIV NR. CAMERETA EXISTENTA
(Dark blue line)	RETEA FO AERIANA PROIECTATA
(Light green line)	RETEA FO MONTATA SUBTERAN PROIECTATA
DELGAZ 1	INDICATIV NR. STALP BETON EXISTENT IN ZONA DJ SI UAT
TELEKOM 1	INDICATIV NR. STALP LEMN EXISTENT IN ZONA DJ SI UAT
ORANGE 001	INDICATIV NR. STALP PROIECTAT ZONA DJ SI UAT
SL	INDICATIV TIP STALP LEMN EXISTENT UAT
SB	INDICATIV TIP STALP BETON EXISTENT UAT
SC DJ PROIECTAT	INDICATIV TIP STALP COMPOSIT PROIECTAT DJ
SC PROIECTAT	INDICATIV TIP STALP COMPOSIT PROIECTAT UAT
SL DJ	INDICATIV TIP STALP LEMN EXISTENT DJ
SB DJ	INDICATIV TIP STALP BETON EXISTENT DJ
(Red dot)	STALPI PROIECTATI
(Black dot)	STALPI EXISTENTI
(Dashed line)	AX DRUM
(Yellow line)	MARGINE DRUM
(Blue line)	LIMITA PROPRIETATE
(Pink line)	LIMITA UNITATE ADMINISTRATIV TERITORIALA
(Red line)	LIMITA INTRAVILAN

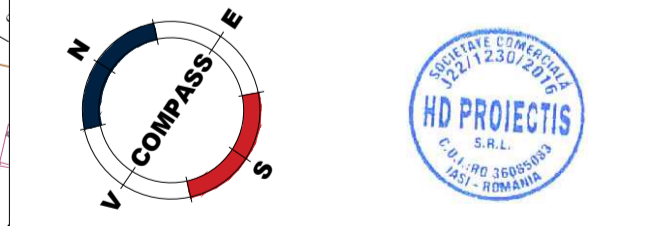

Verificator / Expert	NUME	SEMNATURA	CERINTA
NR. V.566	ING ROTARESCU A. IOAN	[Signature]	A1, A2
REFERAT/EXPERTIZA NR./DATA			
NR. _____ din _____			
PROIECTANT: S.C. HD PROIECTIS S.R.L. Sediul social: Bld. Carol I, Nr.4, Cladirea Habitat Proiect, Corp A, Etaj 2, Cam. 205-206, IASI J22/1230/2016 - R036085083			
SPECIFICATIE	NUME	SEMNATURA	SCARA
SEF PROIECT	ING. PRISACARU ANDREI	[Signature]	1:1000
PROIECTAT	ING. ALUCULESEI C.	[Signature]	DATA:
VERIFICAT	ING. CHRISLA IONUT	[Signature]	12.2021
DESEINAT	ARB. LORIN MARTINEC	[Signature]	
ORANGE ROMANIA S.A. B-dul Lascar Catargiu, nr. 47-53, Europe House, sector 1, Bucuresti CUI: 9010105, 340/10178/1996			PROIECT NR.: 931 2021
TITLU PROIECT: INSTALARE TRASEU FIBRA OPTICA SUBTERAN SI AERIAN (RETEA FTTH PE STALPI) DELGAZ GRID S.A. SI NOI PROIECTATI, IN COMUNA CORDUN, JUDETUL NEAMT			Faza: D.T.A.C. P.TH.+D.E.
DENUMIRE PLANSA: PLAN DE SITUATIE CU LUCRARI PROIECTATE IN SAT PILDESTI, UAT CORDUN, JUD. NEAMT			PLANSA NR. T24
FORMAT PLANSA: 841mm x 594mm			

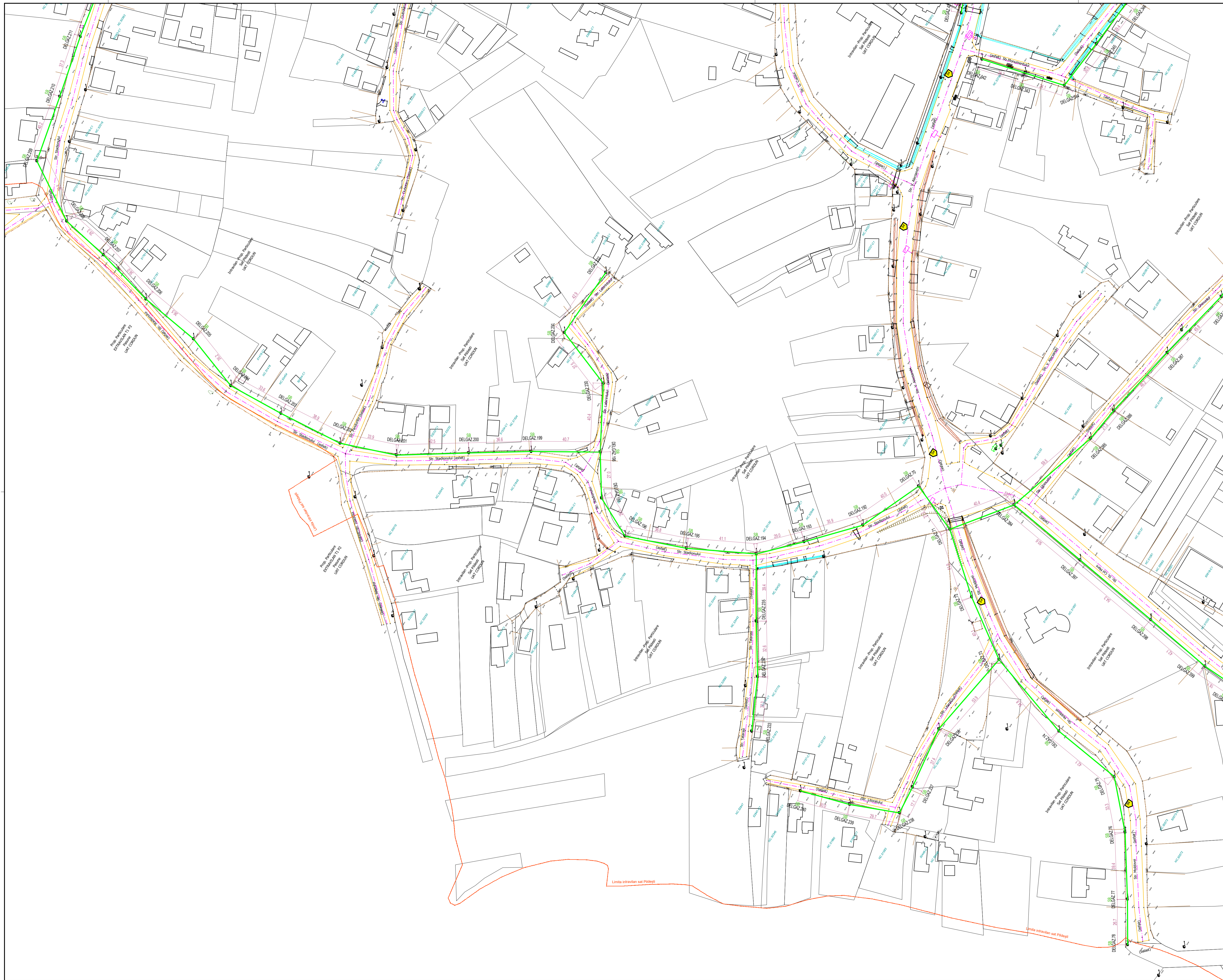

LEGENDA

LS	LUNGIME SANT 0.4 x 1.2 m
LT	LATIME TUB
1x40mm	NUMAR x DIAMETRU MONOTUB HOPE PROIECTAT
---	RETEA FO EXISTENTA MONTATA SUBTERAN
---	CANALIZATIE FO SUBTERANA EXISTENTA
---	CAMERETA EXISTENTA
---	EXISTENTA
---	INDICATIV NR. CAMERETA EXISTENTA
---	RETEA FO AERIANA PROIECTATA
---	RETEA FO MONTATA SUBTERAN PROIECTATA
DELGĂZ 1	INDICATIV NR. STALP BETON EXISTENT IN ZONA DJ SI UAT TELEKOM 1
ORANGE 001	INDICATIV NR. STALP PROIECTAT ZONA DJ SI UAT
SL	INDICATIV TIP STALP LEMN EXISTENT UAT
SB	INDICATIV TIP STALP BETON EXISTENT UAT
SC DJ PROIECTAT	INDICATIV TIP STALP COMPOSIT PROIECTAT DJ
SC PROIECTAT	INDICATIV TIP STALP COMPOSIT PROIECTAT UAT
SL DJ	INDICATIV TIP STALP LEMN EXISTENT DJ
SB DJ	INDICATIV TIP STALP BETON EXISTENT DJ
---	STALPI PROIECTATI
---	STALPI EXISTENTI
---	AX DRUM
---	MARGINE DRUM
---	LIMITA PROPRIETATE
---	LIMITA UNITATE ADMINISTRATIV TERITORIALA
---	LIMITA INTRAVILAN

COMPASS

HD PROIECTIS S.R.L.

Verificator / Expert	NUME	SEMNATURA	CERINTA
NR. V.566	ING ROTARESCU A. IOAN		A1, A2
REFERAT/EXPERTIZA NR./DATA			
NR. _____ din _____			
PROIECTANT: S.C. HD PROIECTIS S.R.L. Sediul societati: Bld. Carol I, Nr.4, Cladirea Habitat Protect, Corp A, Etaj 2, Cam. 205-206, IASI J22/1230/2016 - R036085083			
SPECIFICATIE	NUME	SEMNATURA	SCARA:
SEF PROIECT	ING. PRISACARU ANDREI		1:1000
PROIECTAT	ING. ALUCULESEI C.		DATA:
VERIFICAT	ING. CHRISLA IONUT		12.2021
DESEINAT	ARH. LORIN MARTINEC		
orange	ORANGE ROMANIA S.A. B-dul Lascar Catargiu, nr. 47-53, Europe House, sector 1, Bucuresti CUI: 9010105, J40/10178/1996	PROIECT NR.:	93
TITLU PROIECT: INSTALARE TRASEU FIBRA OPTICA SUBTERAN SI AERIAN (RETEA FTTH PE STALPI) DELGAZ GRID S.A. SI NOI PROIECTATI, IN COMUNA CORDUN, JUDETUL NEAMT			Faza:
DENUMIRE PLANSA: PLAN DE SITUATIE CU LUCRARI PROIECTATE IN SAT PILDESTI, UAT CORDUN, JUD. NEAMT			PLANSA NR.:
			T25
FORMAT PLANSA: 841mm x 594mm			

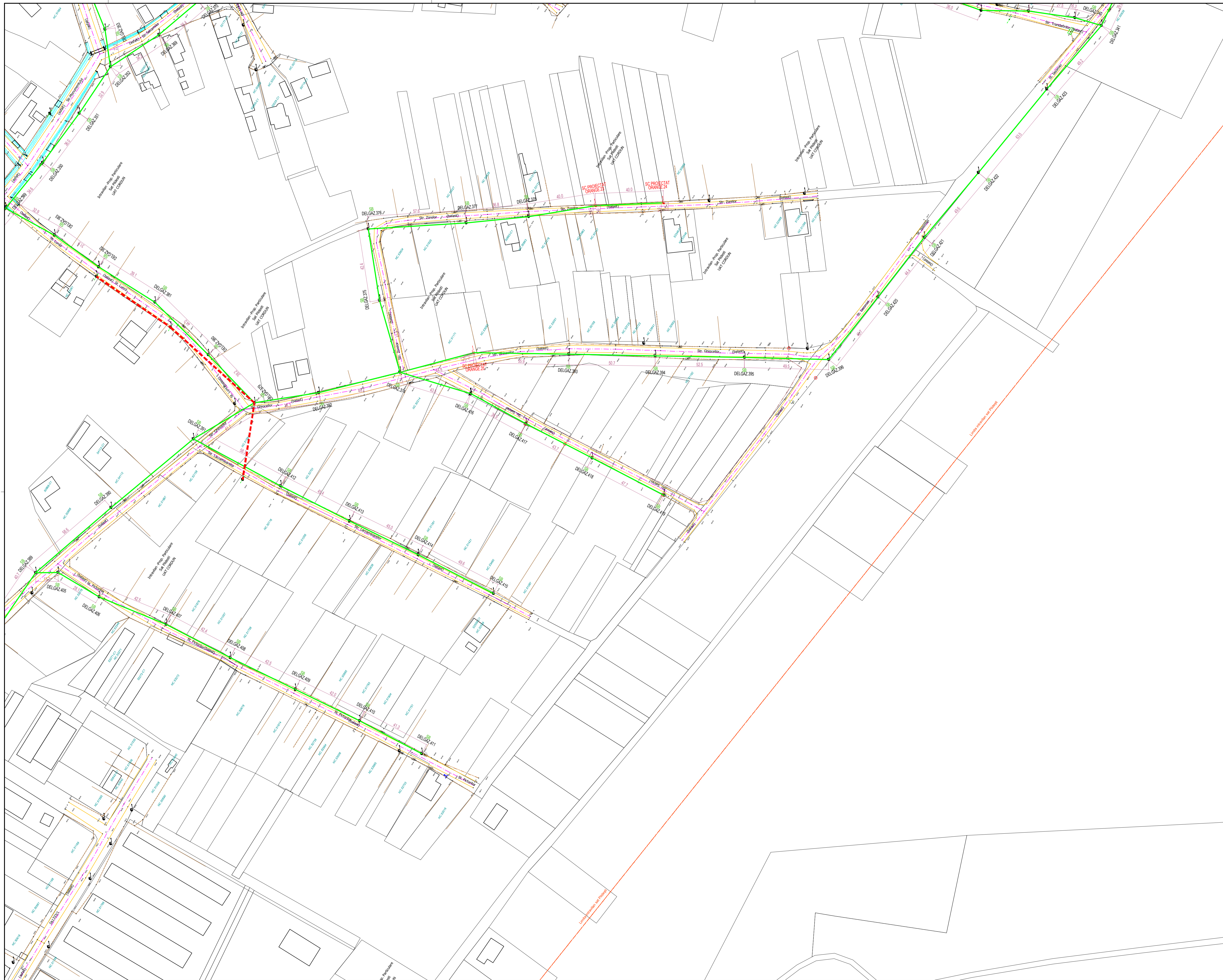

LEGENDA

LS	LUNGIME SANT 0.4 x 1.2 m
LT	LATIME TUB
1x10mm	NUMAR x DIAMETRU MONOTUB HOPE PROIECTAT
---	RETEA FO EXISTENTA MONTATA SUBTERAN
---	CANALIZATIE FO SUBTERANA EXISTENTA
---	CAMERETA EXISTENTA
---	INDICATIV NR. CAMERETA EXISTENTA
---	RETEA FO AERIANA PROIECTATA
---	RETEA FO MONTATA SUBTERAN PROIECTATA
DELGAZ 1	INDICATIV NR. STALP BETON EXISTENT IN ZONA DJ SI UAT TELEKOM 1
ORANGE 001	INDICATIV NR. STALP PROIECTAT ZONA DJ SI UAT
SL	INDICATIV TIP STALP LEMN EXISTENT UAT
SB	INDICATIV TIP STALP BETON EXISTENT UAT
SC DJ PROIECTAT	INDICATIV TIP STALP COMPOSIT PROIECTAT DJ
SC PROIECTAT	INDICATIV TIP STALP COMPOSIT PROIECTAT UAT
SL DJ	INDICATIV TIP STALP LEMN EXISTENT DJ
SB DJ	INDICATIV TIP STALP BETON EXISTENT DJ
---	STALPI PROIECTATI
---	STALPI EXISTENTI
---	AX DRUM
---	MARGINE DRUM
---	LIMITA PROPRIETATE
---	LIMITA UNITATE ADMINISTRATIV TERITORIALA
---	LIMITA INTRAVILAN

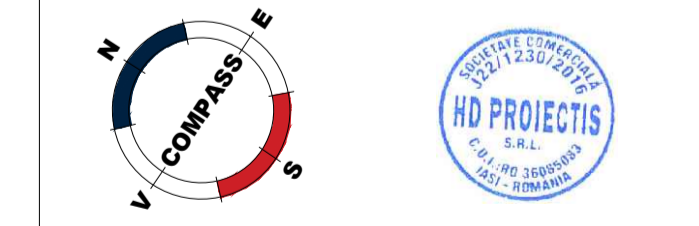

Verificator / Expert	NUME	SEMNTURA	CERINTA
NR. V.566	ING ROTARESCU A. IOAN		A1, A2
REFERAT/EXPERTIZA NR./DATA			
NR. _____ din _____			
PROIECTANT: S.C. HD PROIECTIS S.R.L. Sediul societati: Bld. Carol I, Nr.4, Cladirea Habitat Proiect, Corp A, Etaj 2, Cam. 205-206, IASI J22/1230/2016 - R036085083			
SPECIFICATIE	NUME	SEMNTURA	SCARA:
SEF PROIECT	ING. PRISACARU ANDREI		1:1000
PROIECTAT	ING. ALICULESEI C.		DATA:
VERIFICAT	ING. CHERILA IONUT		12.2021
DESEINAT	ARBH. LORIN MARTINEUC		
orange	ORANGE ROMANIA S.A. B-dul Lascar Catargiu, nr. 47-53, Europe House, sector 1, Bucuresti CUI: 9010105, J40/10178/1996		PROIECT NR.: 93 2021
TITLU PROIECT: INSTALARE TRASEU FIBRA OPTICA SUBTERAN SI AERIAN (RETEA FTTH) PE STALPI DELGAZ GRID S.A. SI NOI PROIECTATI, IN COMUNA CORDUN, JUDETLU NEAMT			Faza: D.T.A.C. P.TH.+D.E.
DENUMIRE PLANSA: PLAN DE SITUATIE CU LUCRARI PROIECTATE IN SAT PILDESTI, UAT CORDUN, JUD. NEAMT			PLANSĂ NR. T27
FORMAT PLANSA: 841mm x 594mm			

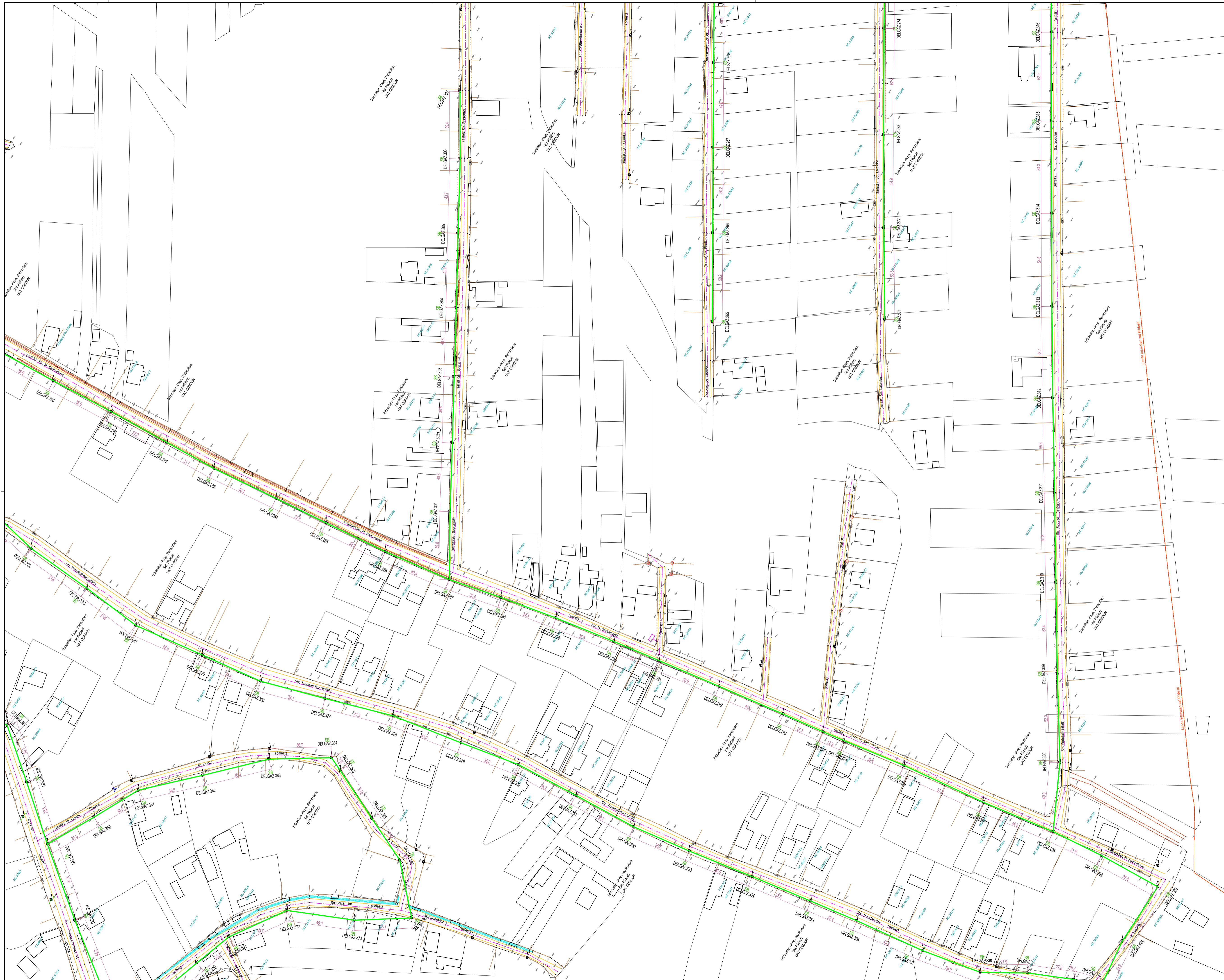

LEGENDA

LS	LUNGIME SANT 0.4 x 1.2 m
LT	LATIME TUB
1x10mm	NUMAR x DIAMETRU MONOTUB HOPE PROIECTAT
—	RETEA FO EXISTENTA MONTATA SUBTERAN
—	CANALIZATIE FO SUBTERANA EXISTENTA
—	CAMERETA EXISTENTA
EXISTENTA	INDICATIV NR. CAMERETA EXISTENTA
—	RETEA FO AERIANA PROIECTATA
—	RETEA FO MONTATA SUBTERAN PROIECTATA
DELGAZ 1	INDICATIV NR. STALP BETON EXISTENT IN ZONA DJ SI UAT
TELEKOM 1	INDICATIV NR. STALP LEHM EXISTENT IN ZONA DJ SI UAT
ORANGE 001	INDICATIV NR. STALP PROIECTAT ZONA DJ SI UAT
SL	INDICATIV TIP STALP LEHM EXISTENT UAT
SB	INDICATIV TIP STALP BETON EXISTENT UAT
SC DJ PROIECTAT	INDICATIV TIP STALP COMPOSIT PROIECTAT DJ
SC PROIECTAT	INDICATIV TIP STALP COMPOSIT PROIECTAT UAT
SL DJ	INDICATIV TIP STALP LEHM EXISTENT DJ
SB DJ	INDICATIV TIP STALP BETON EXISTENT DJ
—	STALPI PROIECTATI
—	STALPI EXISTENTI
—	AX DRUM
—	MARGINE DRUM
—	LIMITA PROPRIETATE
—	LIMITA UNITATE ADMINISTRATIV TERITORIALA
—	LIMITA INTRAVILAN

COMPASS

HD PROIECTIS S.R.L.

Verificator / Expert	NUME	SEMNAURA	CERINTA
NR. V.566	ING. ROTARESCU A. IOAN		A1, A2
REFERAT/EXPERTIZA NR./DATA			
NR. _____ din _____			
PROIECTANT: S.C. HD PROIECTIS S.R.L. Sediul societii: Bld. Carol I, Nr.4, Cladirea Habitat Protect, Corp A, Etaj 2, Cam. 205-206, IASI J22/1230/2016 - R036085083			
SPECIFICATIE	NUME	SEMNAURA	SCARA:
SEF PROIECT	ING. PRISACARU ANDREI		1:1000
PROIECTAT	ING. ALICULESEI C.		DATA:
VERIFICAT	ING. CHERILA IONUT		12.2021
DESEINAT	ARB. LORIN MARTINEUC		
	ORANGE ROMANIA S.A. B-dul Lascar Catargiu, nr. 47-53, Europe House, sector 1, Bucuresti CUI: 9010105, 340/10178/1996		PROIECT NR.: 93 2021
TITLU PROIECT: INSTALARE TRASEU FIBRA OPTICA SUBTERAN SI AERIAN (RETEA FTTH PE STALPI) DELGAZ GRID S.A. SI NOI PROIECTATI, IN COMUNA CORDUN, JUDETUL NEAMT			FAZA: D.T.A.C. P.TH.+D.E.
DENUMIRE PLANSA: PLAN DE SITUATIE CU LUCRARI PROIECTATE IN SAT PILDESTI, UAT CORDUN, JUD. NEAMT			PLANSA NR. T28
FORMAT PLANSA: 841mm x 594mm			

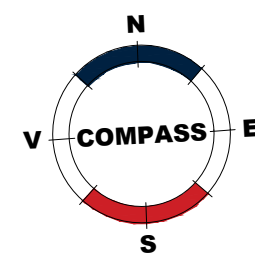

LEGENDA	
LS:	LUNGIME SANT 0.4 x 1.2 m
LT:	LATIME TUB
1x40mm	NUMAR x DIAMETRU MONOTUB HDPE PROIECTAT
	RETEA FO EXISTENTA MONTATA SUBTERAN
	CANALIZATIE FO SUBTERANA EXISTENTA
	CAMERETA EXISTENTA
EXISTENTA	INDICATIV NR. CAMERETA EXISTENTA
	RETEA FO AERIANA PROIECTATA
	RETEA FO MONTATA SUBTERAN PROIECTATA
DELGAZ.1	INDICATIV NR. STALP BETON EXISTENT IN ZONA DJ SI UAT
TELEKOM.1	INDICATIV NR. STALP LEMN EXISTENT IN ZONA DJ SI UAT
ORANGE.001	INDICATIV NR. STALP PROIECTAT ZONA DJ SI UAT
SL	INDICATIV TIP STALP LEMN EXISTENT UAT
SB	INDICATIV TIP STALP BETON EXISTENT UAT
SC DJ PROIECTAT	INDICATIV TIP STALP COMPOSIT PROIECTAT DJ
SC PROIECTAT	INDICATIV TIP STALP COMPOSIT PROIECTAT UAT
SL DJ	INDICATIV TIP STALP LEMN EXISTENT DJ
SB DJ	INDICATIV TIP STALP BETON EXISTENT DJ
	STALPI PROIECTATI
	STALPI EXISTENTI
	AX DRUM
	MARGINE DRUM
	LIMITA PROPRIETATE
	LIMITA UNITATE ADMINISTRATIV TERITORIALA
	LIMITA INTRAVILAN

Verificator / Expert	NUME	SEMNTURA	CERINTA	REFERAT/EXPERTIZA NR./DATA
NR. V.566	ING ROTARESCU A. IOAN		A1, A2	
PROIECTANT:		S.C. HD PROIECTIS S.R.L. Sediu social: Bld. Carol I, Nr.4, Cladirea Habitat Project, Corp A, Etaj 2, Cam. 205-206, IASI 122/1230/2016 - RO36085083		ORANGE ROMANIA S.A. B-dul Lascar Catargiu, nr. 47-53, Europe House, sector 1, Bucuresti CUI: 9010105, 340/10178/1996
FORMAT PLANSA: 297 x 750 mm				PROJECT NR.: 93 2021
SPECIFICATIE NUME SEMNTURA SCARA:				Faza: D.T.A.C. + P.TH.+D.E. PLANSA NR.: T29
SEF PROIECT	ING. PRISACARU ANDREI		1:1000	
PROIECTAT	ING. ALUCULESEI C.		DATA:	
VERIFICAT	ING. CHIRILA IONUT		12.2021	
DESENAT	ARH. LORIN MARTINIUC			
TITLU PROIECT: INSTALARE TRASEU FIBRA OPTICA SUBTERAN SI AERIAN (RETEA FTTH) PE STALPII DELGAZ GRID S.A. SI NOI PROIECTATI, IN COMUNA CORDUN, JUDETUL NEAMT				
DENUMIRE PLANSA: PLAN DE SITUATIE CU LUCRARI PROIECTATE IN UAT CORDUN, JUD. NEAMT				

structura trotuar echivalenta cu cea existenta

folie avertizare
pamant natural compactat
retea fibra optica
Tub Ø 40 mm
pamant natural

strat pamant vegetal 10 cm

folie avertizare
pamant natural compactat
retea fibra optica
Tub Ø 40 mm
pamant natural

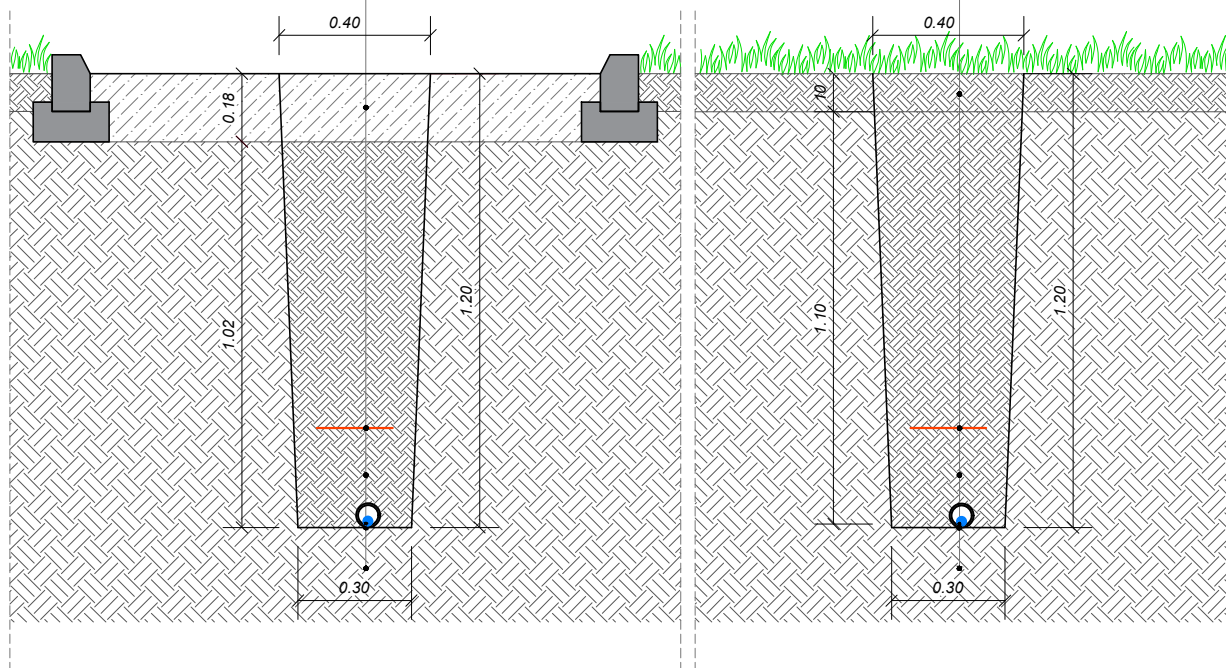

SECTIUNE TRANSVERSALA
PRIN SANT IN TROTUAR

SECTIUNE TRANSVERSALA
PRIN SANT IN SPATIU VERDE



Verificator / Expert	NUME	SEMNTATURA	CERINTA	REFERAT/EXPERTIZA NR./DATA	
NR. V.566	ING ROTARESCU A. IOAN		A1, A2		
S.C. HD PROECTIS S.R.L. Sediu social: Bld. Carol I, Nr.4, Cladirea Habitat Proiect, Corp A, Etaj 2, Cam. 205-206, IASI J22/1230/2016 - RO36085083		ORANGE ROMANIA S.A. B-dul Lascar Catargiu, nr. 47-53, Europe House, sector 1, Bucuresti CUI: 9010105, J40/10178/1996		PROIECT NR.: 93 2021	
FORMAT PLANSĂ: 210 x 297mm				TITLU PROIECT: INSTALARE TRASEU FIBRA OPTICA SUBTERAN SI AERIAN (RETEA FTTH) PE STALPII DELGAZ GRID S.A. SI NOI PROIECTATI, IN COMUNA CORDUN, JUDETUL NEAMT	Faza: D.T.A.C. + P.TH.+D.E.
SPECIFICATIE	NUME	SEMNTATURA	SCARA:	DENUMIRE PLANSĂ: DETALIU DE EXECUTIE - SECTIUNE TRANSVERSALA PRIN SANT IN TROTUAR / SPATIU VERDE	
SEF PROIECT	ING. PRISACARU ANDREI		1:20		
PROIECTAT	ING. ALUCULESEI C.		DATA:		
VERIFICAT	ING. CHIRILA IONUT		12.2021		
DESENAT	ARH. LORIN MARTINIUC				
				PLANSĂ NR.: DS1	

aparatoare "U"

Tub Ø 40 mm

cablu fibra optica

stalp din beton armat

sectiune A-A - vedere plana

bratară metalică

aparatoare "U"

Tub Ø 40 mm

retea fibra optica

stalp din beton armat

bratară metalică

structura trotuar echivalentă cu cea existentă

folie avertizare

pământ natural compactat

retea fibra optica







Tub Ø 40 mm

pământ natural

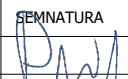

fundatie stalp

sectiune B-B - vedere laterala





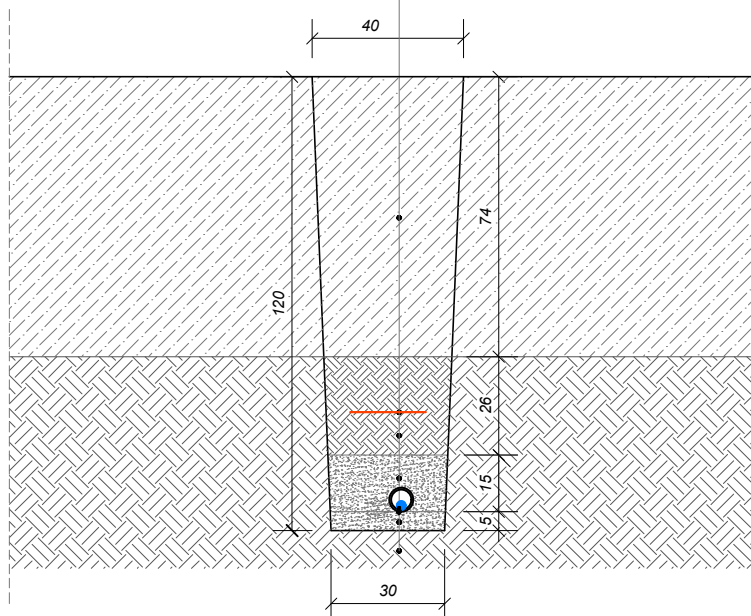

Verificator / Expert	NUME	SEMNTATURA	CERINTA	REFERAT/EXPERTIZA NR./DATA	
NR. V.566	ING ROTARESCU A. IOAN		A1, A2		
 S.C. HD PROECTIS S.R.L. Sediul social: Bld. Carol I, Nr.4, Cladirea Habitat Proiect, Corp A, Etaj 2, Cam. 205-206, IASI J22/1230/2016 - RO36085083		 ORANGE ROMANIA S.A. B-dul Lascar Catargiu, nr. 47-53, Europe House, sector 1, Bucuresti CUI: 9010105, J40/10178/1996		PROIECT NR.: 93 2021	
FORMAT PLANSĂ: 210 x 297mm				TITLU PROIECT: INSTALARE TRASEU FIBRA OPTICA SUBTERAN SI AERIAN (RETEA FTTH) PE STALPII DELGAZ GRID S.A. SI NOI PROIECTATI, IN COMUNA CORDUN, JUDETUL NEAMT	Faza: D.T.A.C. + P.TH.+D.E.
SPECIFICATIE	NUME	SEMNTATURA	SCARA:	DENUMIRE PLANSĂ: DETALIU DE EXECUTIE - RACORD LA STALP - SECTIUNE A-A VEDERE PLANA, SECTIUNE B-B VEDERE LATERALA	
SEF PROIECT	ING. PRISACARU ANDREI		1:20		
PROIECTAT	ING. ALUCULESEI C.		DATA:		
VERIFICAT	ING. CHIRILA IONUT		12.2021		
DESENAT	ARH. LORIN MARTINIUC			PLANSĂ NR.: DS2	

structura rutiera
 echivalenta cu cea existenta
 folie avertizare
 pamant natural compactat
 strat nisip 15 cm
 retea fibra optica
 Tub Ø 40 mm
 strat nisip 5 cm
 pamant natural



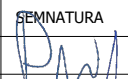



SECTIUNE TRANSVERSALA
 PRIN SANT IN CAROSABIL

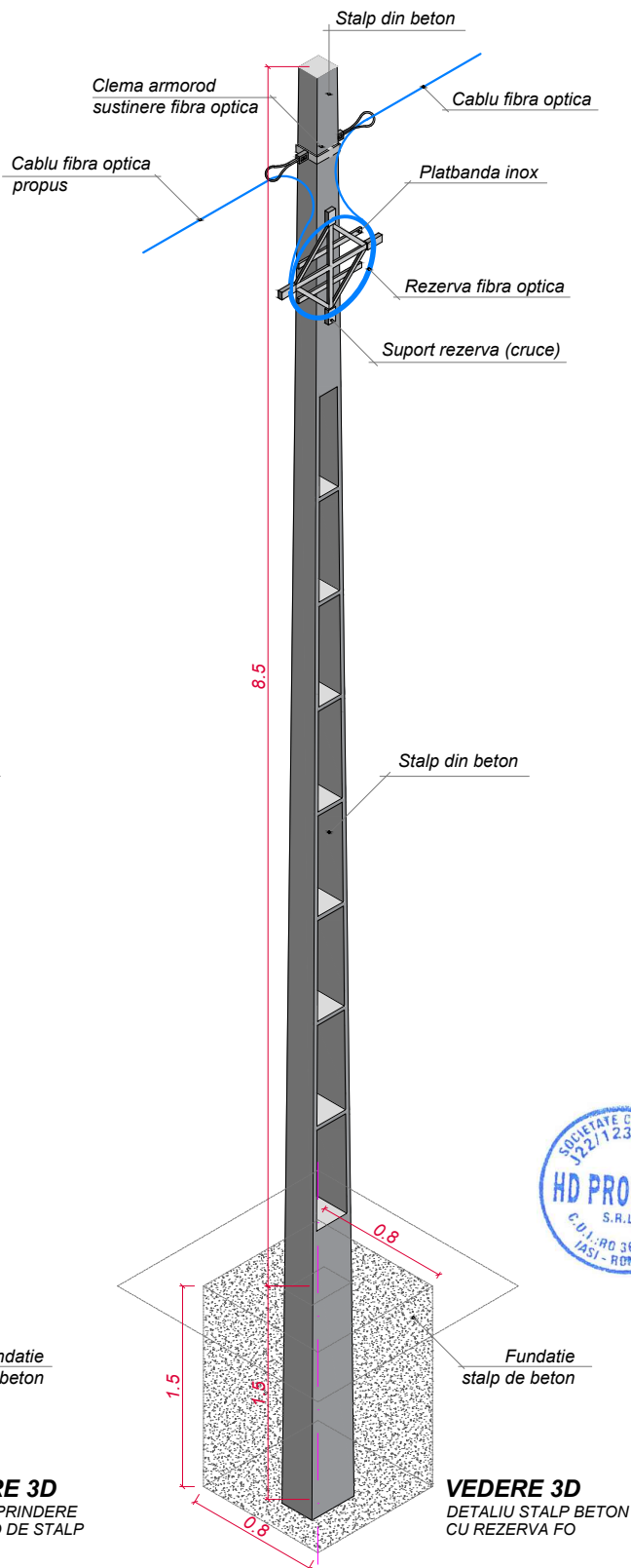
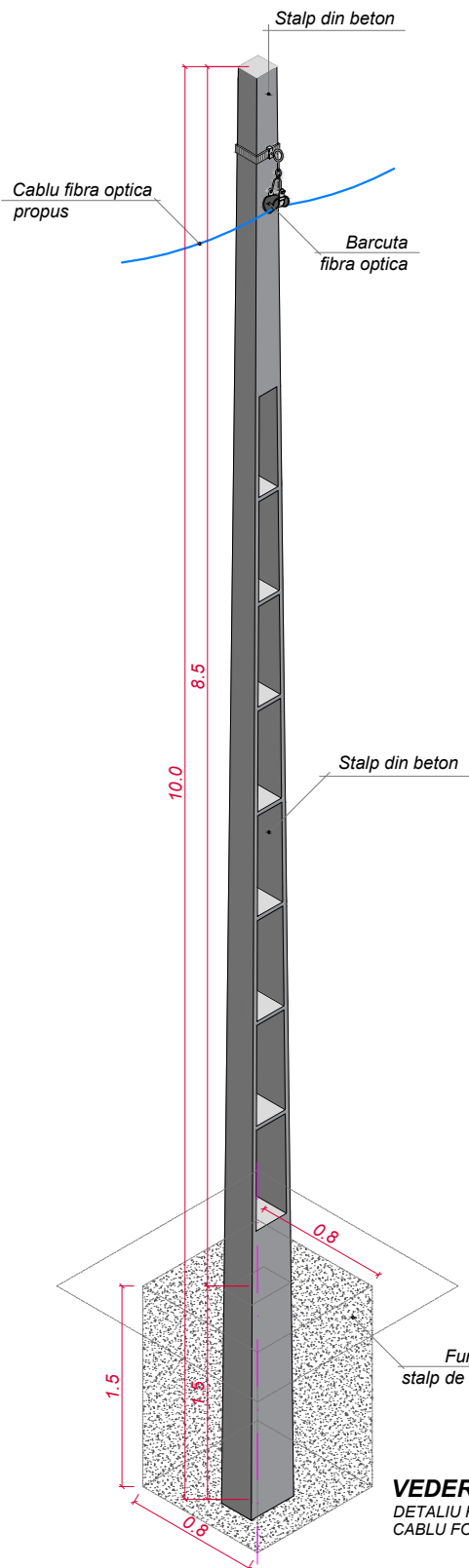

Verificator / Expert	NUME	SEMNATURA	CERINTA	REFERAT/EXPERTIZA NR./DATA	
NR. V.566	ING ROTARESCU A. IOAN		A1, A2		
PROIECTANT:  S.C. HD PROIECTIS S.R.L. Sediu social: Bld. Carol I, Nr.4, Cladirea Habitat Proiect, Corp A, Etaj 2, Cam. 205-206, IASI J22/1230/2016 - RO36085083		 ORANGE ROMANIA S.A. B-dul Lascar Catargiu, nr. 47-53, Europe House, sector 1, Bucuresti CUI: 9010105, J40/10178/1996		PROIECT NR.: 93 2021	
FORMAT PLANSA: 210 x 297mm				TITLU PROIECT: INSTALARE TRASEU FIBRA OPTICA SUBTERAN SI AERIAN (RETEA FTTH) PE STALPII DELGAZ GRID S.A. SI NOI PROIECTATI, IN COMUNA CORDUN, JUDETUL NEAMT	Faza: D.T.A.C. + P.TH.+D.E.
SPECIFICATIE	NUME	SEMNATURA	SCARA:	DENUMIRE PLANSA: DETALIU DE EXECUTIE - SECTIUNE TRANSVERSALA PRIN SANT IN CAROSABIL	
SEF PROIECT	ING. PRISACARU ANDREI		1:20		
PROIECTAT	ING. ALUCULESEI C.		DATA:		
VERIFICAT	ING. CHIRILA IONUT		12.2021		
DESENAT	ARH. LORIN MARTINIUC				
				PLANSA NR.: DS3	

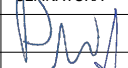

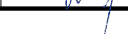
Verificator / Expert	NUME	SEMNTATURA	CERINTA	REFERAT/EXPERTIZA NR./DATA	
NR. V.566	ING ROTARESCU A. IOAN		A1, A2		
 S.C. HD PROIECTIS S.R.L. Sediu social: Bld. Carol I, Nr.4, Cladirea Habitat Proiect, Corp A, Etaj 2, Cam. 205-206, IASI J22/1230/2016 - RO36085083		 ORANGE ROMANIA S.A. B-dul Lascar Catargiu, nr. 47-53, Europe House, sector 1, Bucuresti CUI: 9010105, J40/10178/1996		PROIECT NR.: 93 2021	
FORMAT PLANSA: 210 x 297mm				TITLU PROIECT: INSTALARE TRASEU FIBRA OPTICA SUBTERAN SI AERIAN (RETEA FTTH) PE STALPII DELGAZ GRID S.A. SI NOI PROIECTATI, IN COMUNA CORDUN, JUDETUL NEAMT	Faza: D.T.A.C. + P.TH.+D.E.
SPECIFICATIE	NUME	SEMNTATURA	SCARA:	DENUMIRE PLANSA: DETALIU PRINDERE CABLU FIBRA OPTICA DE STALP	
SEF PROIECT	ING. PRISACARU ANDREI		1:20		
PROIECTAT	ING. ALUCULESEI C.		DATA:		
VERIFICAT	ING. CHIRILA IONUT		12.2021		
DESENAT	ARH. LORIN MARTINIUC				
				PLANSA NR.: DSB1	

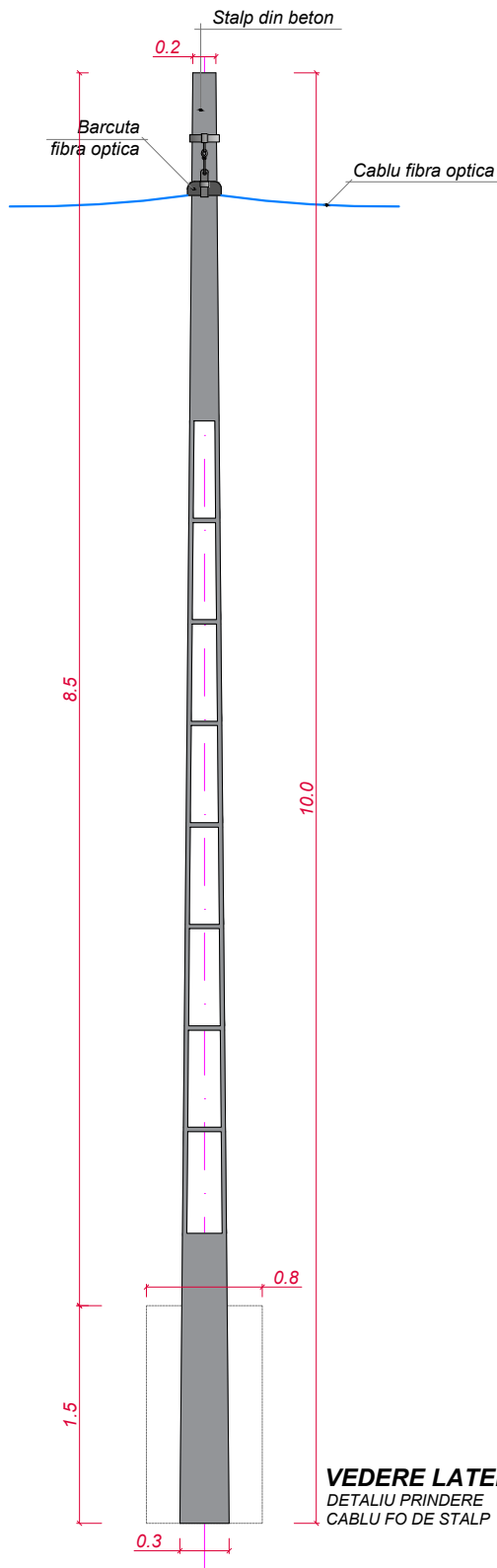

VEDERE LATERALA
 DETALIU PRINDERE
 CABLU FO DE STALP

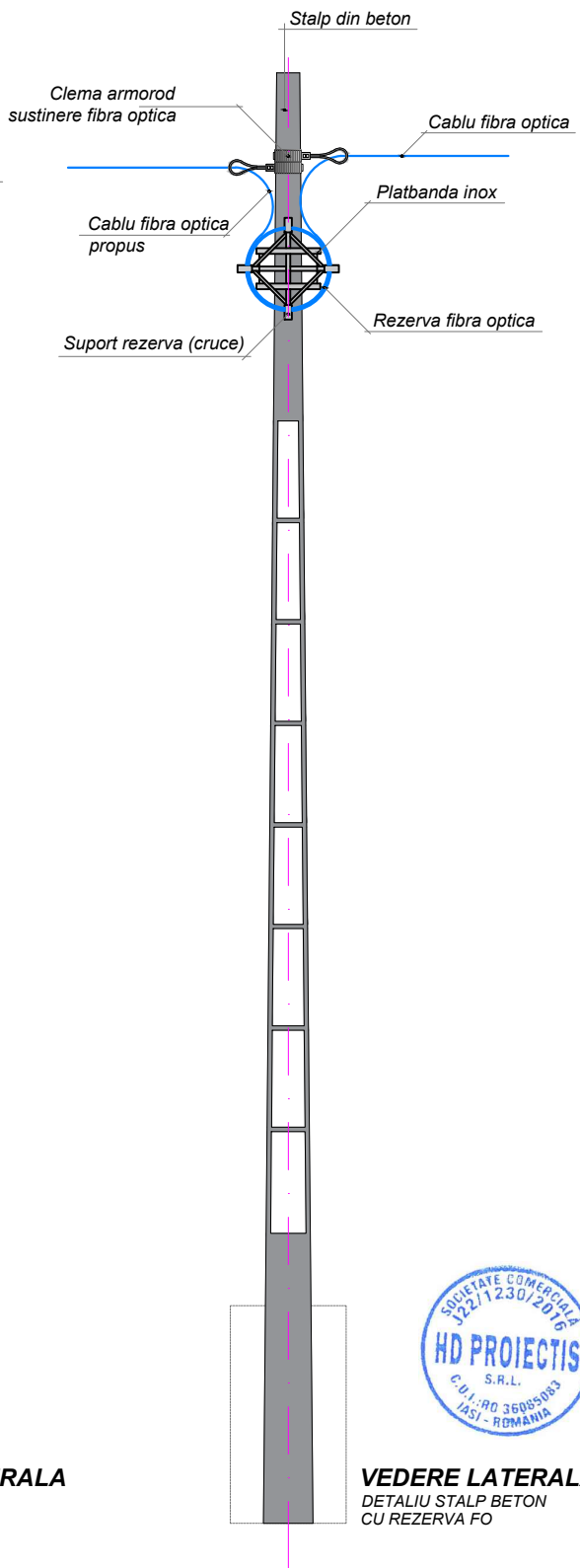

VEDERE LATERALA
 DETALIU STALP BETON
 CU REZERVA FO



Verificator / Expert	NUME	SEMNTATURA	CERINTA	REFERAT/EXPERTIZA NR./DATA	
NR. V.566	ING ROTARESCU A. IOAN		A1, A2		
S.C. HD PROECTIS S.R.L. Sediu social: Bld. Carol I, Nr.4, Cladirea Habitat Proiect, Corp A, Etaj 2, Cam. 205-206, IASI J22/1230/2016 - RO36085083		ORANGE ROMANIA S.A. B-dul Lascar Catargiu, nr. 47-53, Europe House, sector 1, Bucuresti CUI: 9010105, J40/10178/1996		PROIECT NR.: 93 2021	
FORMAT PLANSA: 210 x 297mm				TITLU PROIECT: INSTALARE TRASEU FIBRA OPTICA SUBTERAN SI AERIAN (RETEA FTTH) PE STALPII DELGAZ GRID S.A. SI NOI PROIECTATI, IN COMUNA CORDUN, JUDETUL NEAMT	Faza: D.T.A.C. + P.TH.+D.E.
SPECIFICATIE	NUME	SEMNTATURA	SCARA:	DENUMIRE PLANSA: DETALIU PRINDERE CABLU FIBRA OPTICA DE STALP	
SEF PROIECT	ING. PRISACARU ANDREI		1:20		
PROIECTAT	ING. ALUCULESEI C.		DATA:		
VERIFICAT	ING. CHIRILA IONUT		12.2021		
DESENAT	ARH. LORIN MARTINIUC				
				PLANSA NR.: DSB1	

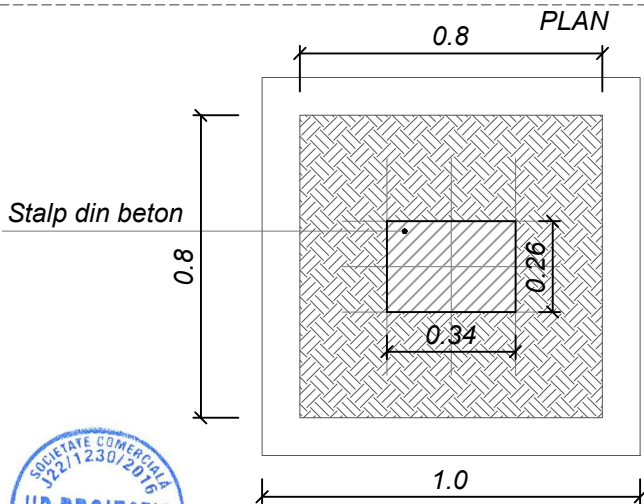

La executarea fundatiilor se vor avea in vedere urmatoarele conditii tehnice:





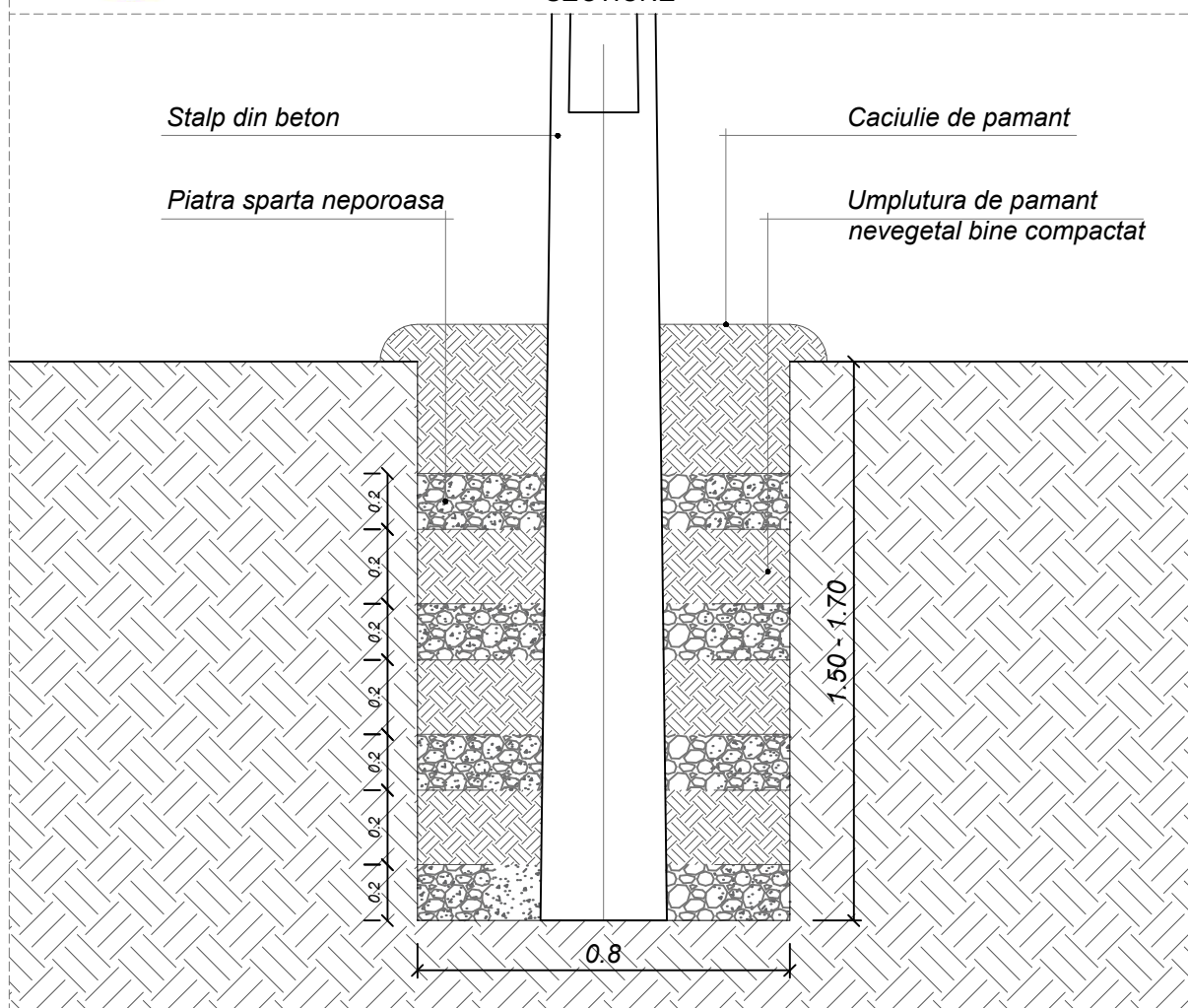

- sapatura se va executa la dimensiunile indicate (fara trepte sau largirea sapaturii);
- burajul se va executa cu straturi succesive de pamant bine compactat (15 cm) si piatra sparta (20 cm) neporoasa (dimensiune max. 5 cm);
- nu se va utiliza pentru umplutura la fundatie pamant vegetal;
- fundatia burata se va executa numai in terenurile in care panza freatica are un nivel mai coborat de 2,00 m de la suprafata;

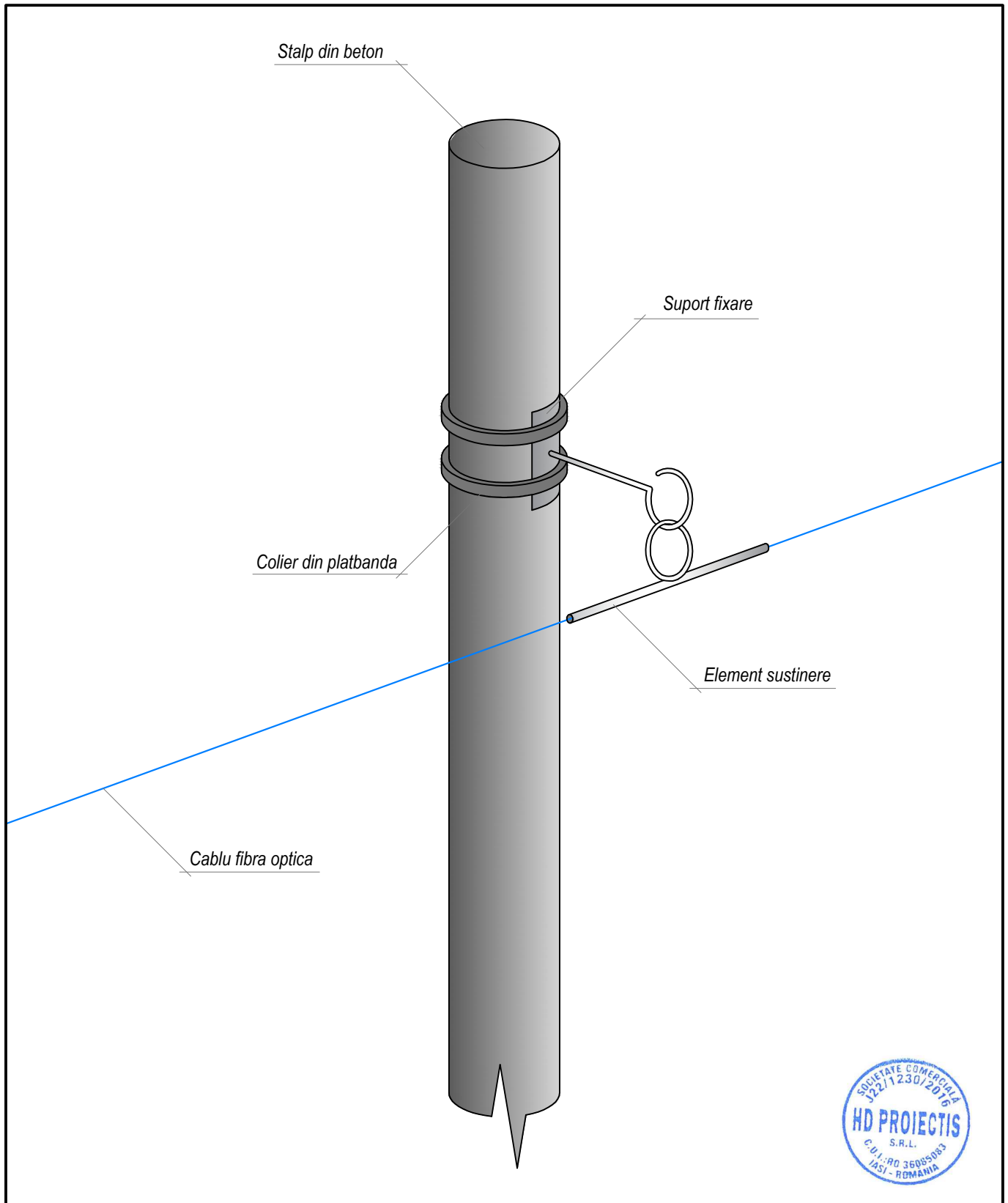
SECTIUNE



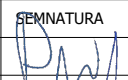



Verificator / Expert	NUME	SEMNATURA	CERINTA	REFERAT/EXPERTIZA NR./DATA	
NR. V.566	ING ROTARESCU A. IOAN		A1, A2		
S.C. HD PROIECTIS S.R.L. Sediu social: Bld. Carol I, Nr.4, Cladirea Habitat Proiect, Corp A, Etaj 2, Cam. 205-206, IASI J22/1230/2016 - RO36085083		ORANGE ROMANIA S.A. B-dul Lascar Catargiu, nr. 47-53, Europe House, sector 1, Bucuresti CUI: 9010105, J40/10178/1996		PROIECT NR.: 93 2021	
FORMAT PLANSA: 210 x 297mm				TITLU PROIECT: INSTALARE TRASEU FIBRA OPTICA SUBTERAN SI AERIAN (RETEA FTTH) PE STALPII DELGAZ GRID S.A. SI NOI PROIECTATI, IN COMUNA CORDUN, JUDETUL NEAMT	Faza: D.T.A.C. + P.TH.+D.E.
SPECIFICATIE	NUME	SEMNATURA	SCARA:	DENUMIRE PLANSA: DETALIU PRINDERE CABLU FIBRA OPTICA DE STALP	
SEF PROIECT	ING. PRISACARU ANDREI		1:20		
PROIECTAT	ING. ALUCULESEI C.		DATA:		
VERIFICAT	ING. CHIRILA IONUT		12.2021		
DESENAT	ARH. LORIN MARTINIUC				
				PLANSA NR.: DSB1	

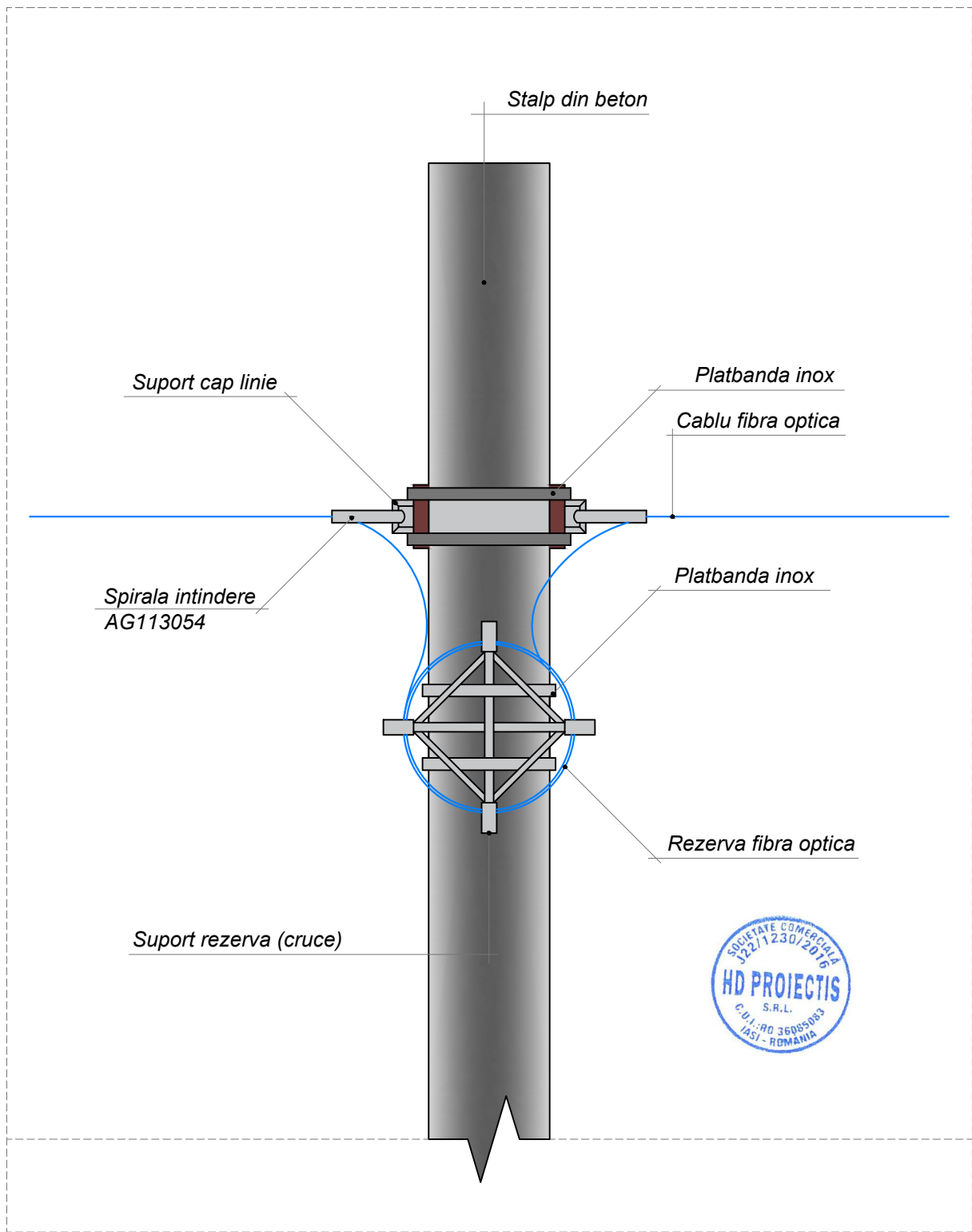

Verificator / Expert	NUME	SEMNATURA	CERINTA	REFERAT/EXPERTIZA NR./DATA	
NR. V.566	ING ROTARESCU A. IOAN		A1, A2		
 S.C. HD PROIECTIS S.R.L. Sediu social: Bld. Carol I, Nr.4, Cladirea Habitat Proiect, Corp A, Etaj 2, Cam. 205-206, IASI J22/1230/2016 - RO36085083		 ORANGE ROMANIA S.A. B-dul Lascar Catargiu, nr. 47-53, Europe House, sector 1, Bucuresti CUI: 9010105, J40/10178/1996		PROIECT NR.: 93 2021	
FORMAT PLANSA: 210 x 297mm				TITLU PROIECT: INSTALARE TRASEU FIBRA OPTICA SUBTERAN SI AERIAN (RETEA FTTH) PE STALPII DELGAZ GRID S.A. SI NOI PROIECTATI, IN COMUNA CORDUN, JUDETUL NEAMT	Faza: D.T.A.C. + P.TH.+D.E.
SPECIFICATIE	NUME	SEMNATURA	SCARA:	DENUMIRE PLANSA: DETALIU PRINDERE CABLU FIBRA OPTICA DE STALP PLANSA NR.: DSB1	
SEF PROIECT	ING. PRISACARU ANDREI		1:20		
PROIECTAT	ING. ALUCULESEI C.		DATA:		
VERIFICAT	ING. CHIRILA IONUT		12.2021		
DESENAT	ARH. LORIN MARTINIUC				

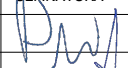

detaliu stalp din lemn cu rezerva de fibra optica

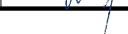
Verificator / Expert	NUME	SEMNAȚURA	CERINȚA	REFERAT/EXPERTIZA NR./DATA	
NR. V.566	ING ROTARESCU A. IOAN		A1, A2		
 S.C. HD PROIECTIS S.R.L. Sediu social: Bld. Carol I, Nr.4, Cladirea Habitat Proiect, Corp A, Etaj 2, Cam. 205-206, IASI J22/1230/2016 - RO36085083		 ORANGE ROMANIA S.A. B-dul Lascar Catargiu, nr. 47-53, Europe House, sector 1, Bucuresti CUI: 9010105, J40/10178/1996		PROIECT NR.: 93 2021	
FORMAT PLANSA: 210 x 297mm				TITLU PROIECT: INSTALARE TRASEU FIBRA OPTICA SUBTERAN SI AERIAN (RETEA FTTH) PE STALPII DELGAZ GRID S.A. SI NOI PROIECTATI, IN COMUNA CORDUN, JUDETUL NEAMT	Faza: D.T.A.C. + P.TH.+D.E.
SPECIFICATIE	NUME	SEMNAȚURA	SCARA:	DENUMIRE PLANSA: DETALIU STALP CU REZERVA DE FIBRA OPTICA PLANSA NR.: DSB2	
SEF PROIECT	ING. PRISACARU ANDREI		1:20		
PROIECTAT	ING. ALUCULESEI C.		DATA:		
VERIFICAT	ING. CHIRILA IONUT		12.2021		
DESENAT	ARH. LORIN MARTINIUC				

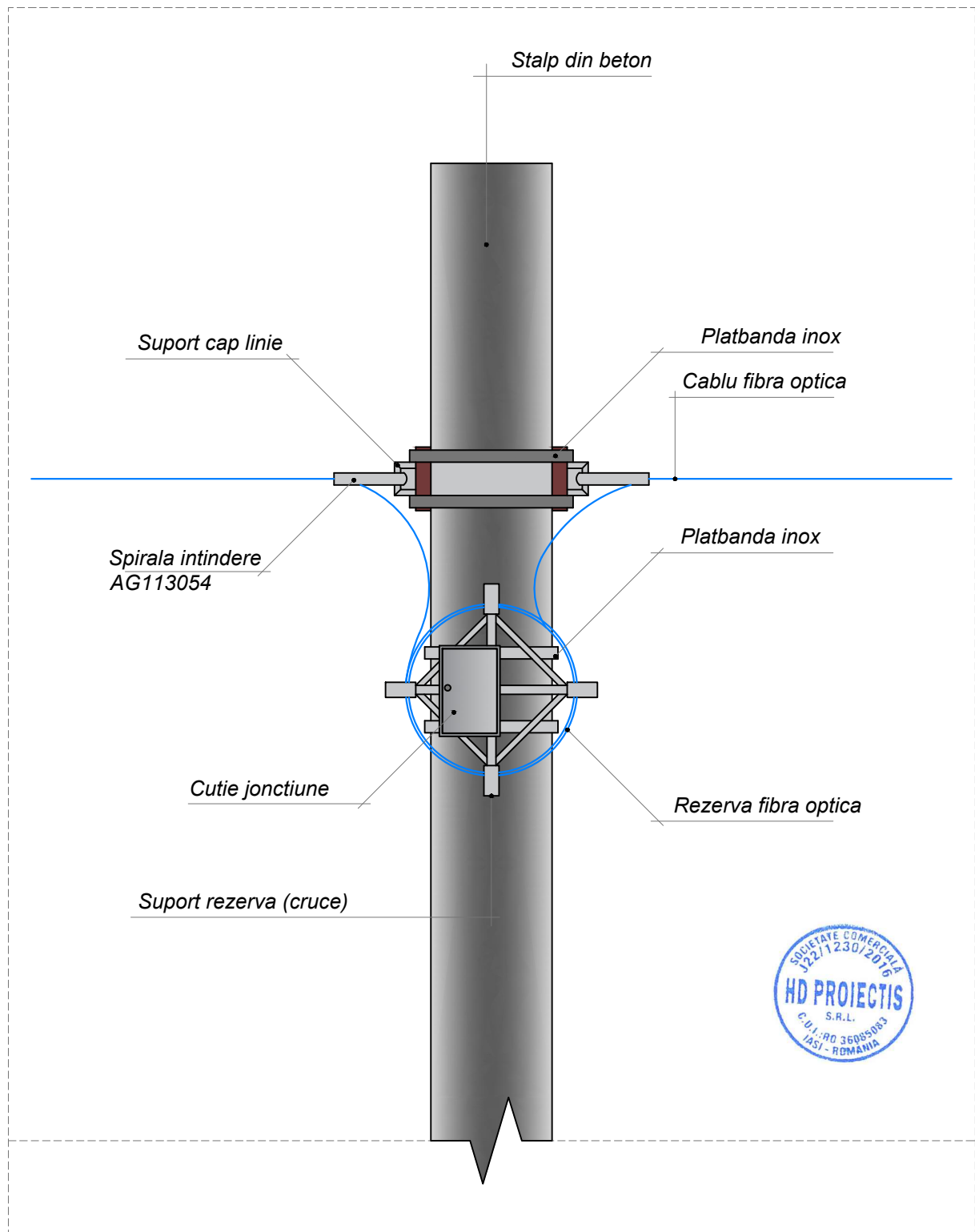

detaliu stalp din lemn cu rezerva de fibra optica si cutie de jonctiune

Verificator / Expert	NUME	SEMNATURA	CERINTA	REFERAT/EXPERTIZA NR./DATA	
NR. V.566	ING ROTARESCU A. IOAN		A1, A2		
S.C. HD PROIECTIS S.R.L. Sediul social: Bld. Carol I, Nr.4, Cladirea Habitat Proiect, Corp A, Etaj 2, Cam. 205-206, IASI J22/1230/2016 - RO36085083		ORANGE ROMANIA S.A. B-dul Lascar Catargiu, nr. 47-53, Europe House, sector 1, Bucuresti CUI: 9010105, J40/10178/1996		PROIECT NR.: 93 2021	
FORMAT PLANSA: 210 x 297mm				TITLU PROIECT: INSTALARE TRASEU FIBRA OPTICA SUBTERAN SI AERIAN (RETEA FTTH) PE STALPII DELGAZ GRID S.A. SI NOI PROIECTATI, IN COMUNA CORDUN, JUDETUL NEAMT	Faza: D.T.A.C. + P.TH.+D.E.
SPECIFICATIE	NUME	SEMNATURA	SCARA:	DENUMIRE PLANSA: DETALIU STALP CU REZERVA DE FIBRA OPTICA SI CUTIE JONCTIUNI PLANSA NR.: DSB3	
SEF PROIECT	ING. PRISACARU ANDREI		1:20		
PROIECTAT	ING. ALUCULESEI C.		DATA:		
VERIFICAT	ING. CHIRILA IONUT		12.2021		
DESEMAT	ARH. LORIN MARTINIUC				

Pamant compactat

Stalp prefabricat
din beton

PLAN

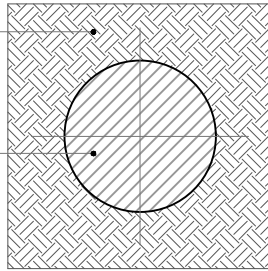

Incastarea stalpilor consta in fixarea stalpilor in gropi si umplerea acestora cu pamant nevegetal bine compactat.

Operatiunile principale la executarea incastrii sunt urmatoarele:

- Trasarea gropilor;
- Saparea gropilor;
- Incastrarea stalpilor;
- Compactarea stratului de pamant nevegetal;
- Executia unei caciulii de pamant de minim 20 cm inaltime de la baza stalpului.





SECTIUNE

Stalp prefabricat
din beton

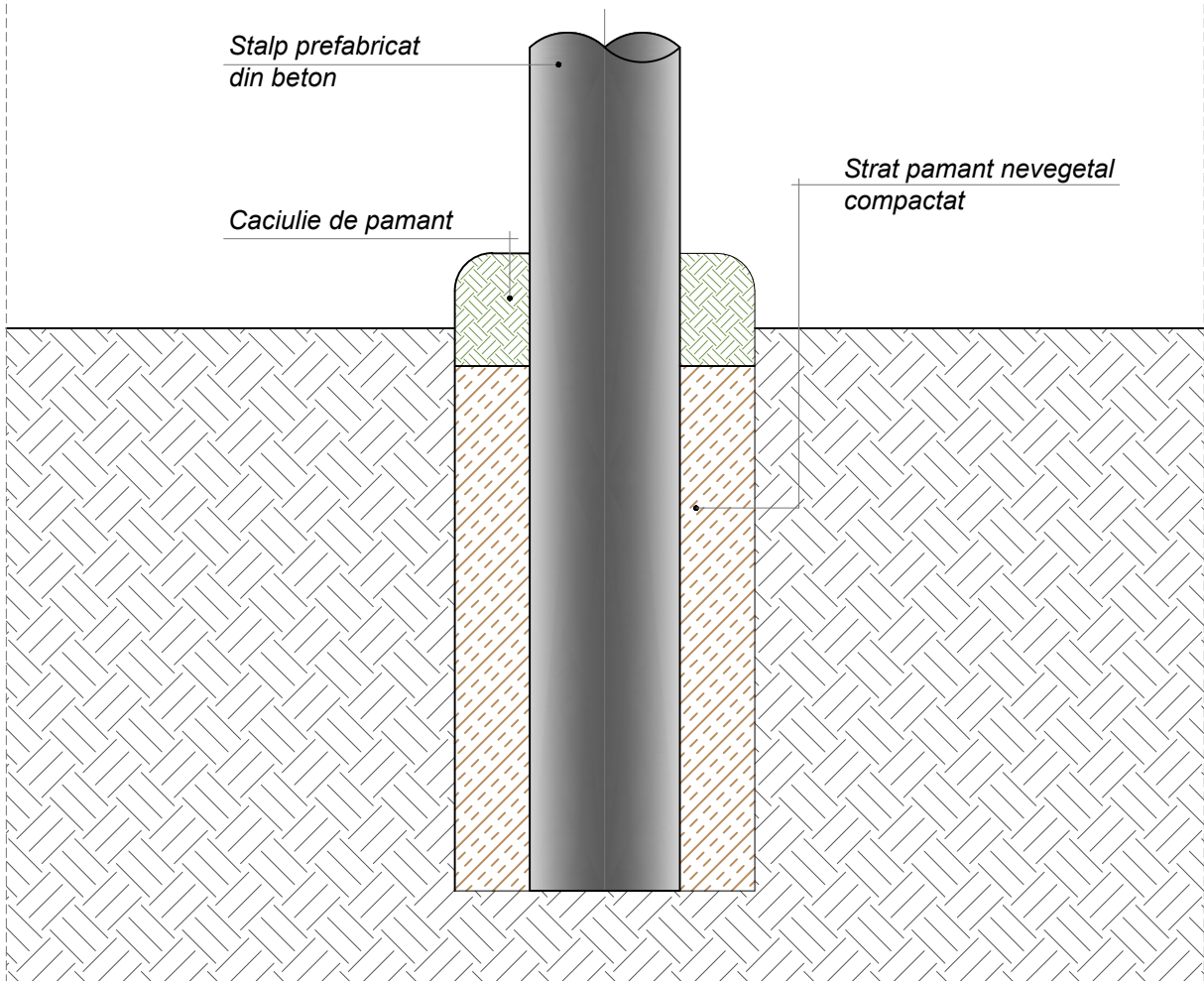
Caciulie de pamant

Strat pamant nevegetal
compactat

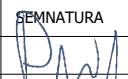

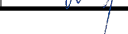

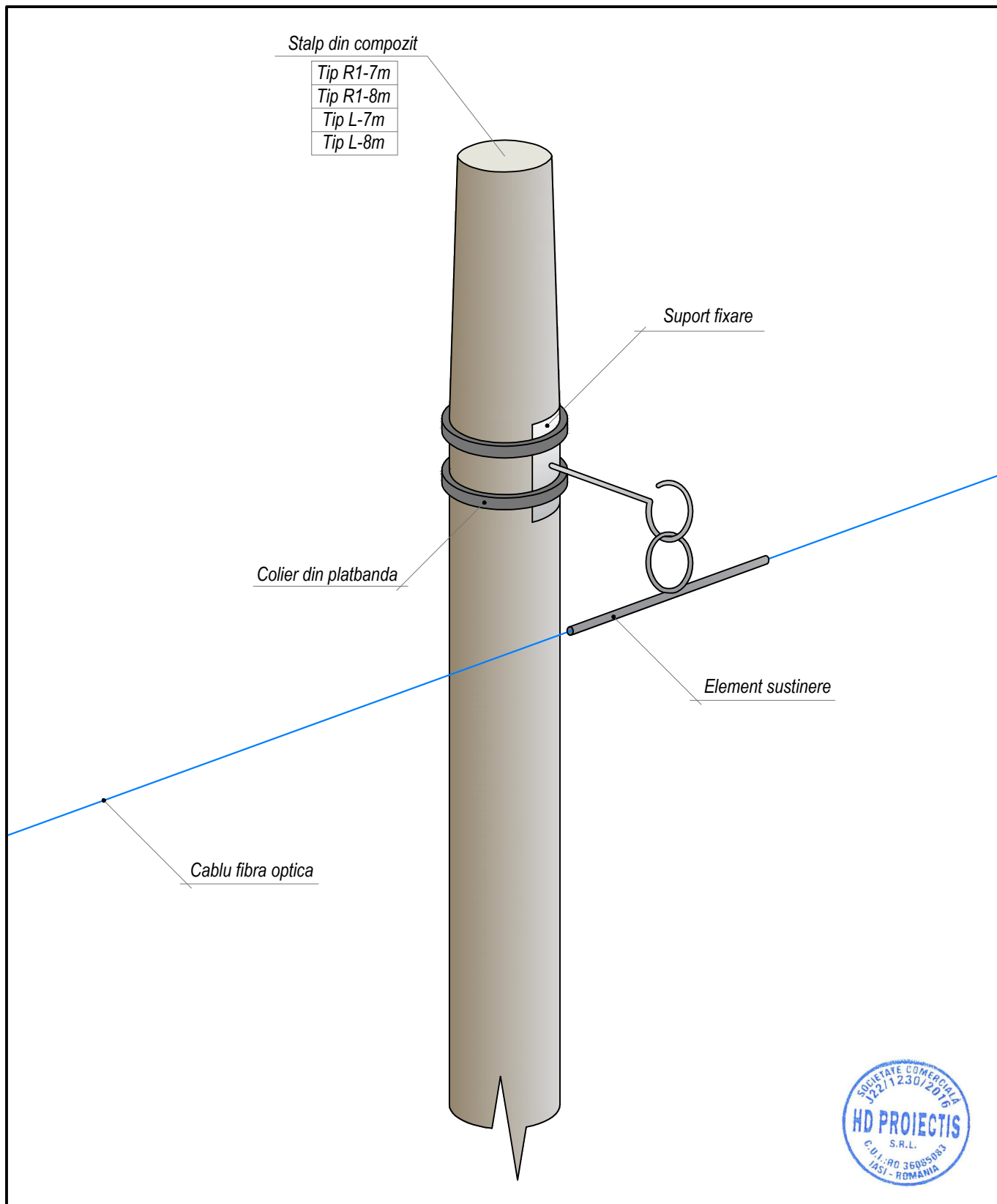

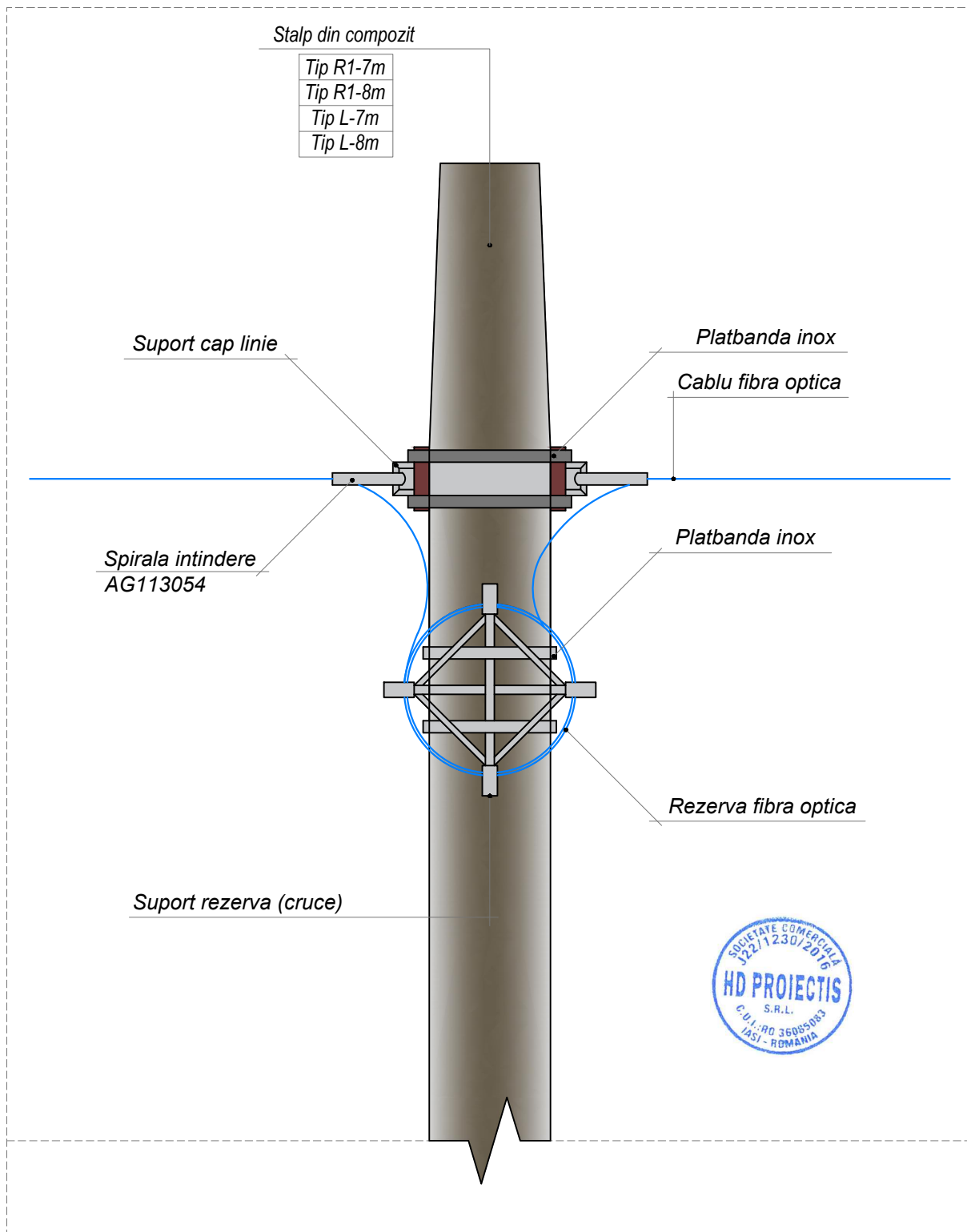

Verificator / Expert	NUME	SEMNTATURA	CERINTA	REFERAT/EXPERTIZA NR./DATA	
NR. V.566	ING ROTARESCU A. IOAN		A1, A2		
PROIECTANT:  S.C. HD PROIECTIS S.R.L. Sediu social: Bld. Carol I, Nr.4, Cladirea Habitat Proiect, Corp A, Etaj 2, Cam. 205-206, IASI J22/1230/2016 - RO36085083		 ORANGE ROMANIA S.A. B-dul Lascar Catargiu, nr. 47-53, Europe House, sector 1, Bucuresti CUI: 9010105, J40/10178/1996		PROIECT NR.: 93 2021	
FORMAT PLANSA: 210 x 297mm				TITLU PROIECT: INSTALARE TRASEU FIBRA OPTICA SUBTERAN SI AERIAN (RETEA FTTH) PE STALPII DELGAZ GRID S.A. SI NOI PROIECTATI, IN COMUNA CORDUN, JUDETUL NEAMT	Faza: D.T.A.C. + P.TH.+D.E.
SPECIFICATIE	NUME	SEMNTATURA	SCARA:	DENUMIRE PLANSA: DETALIU PLANTARE STALP DIN BETON, IN FUNDATIE BURATA	PLANSA NR.: DSB4
SEF PROIECT	ING. PRISACARU ANDREI		1:20		
PROIECTAT	ING. ALUCULESEI C.		DATA:		
VERIFICAT	ING. CHIRILA IONUT		12.2021		
DESENAT	ARH. LORIN MARTINIUC				



Verificator / Expert	NUME	SEMNATURA	CERINTA	REFERAT/EXPERTIZA NR./DATA	
NR. V.566	ING ROTARESCU A. IOAN		A1, A2		
S.C. HD PROIECTIS S.R.L. Sediu social: Bld. Carol I, Nr.4, Cladirea Habitat Proiect, Corp A, Etaj 2, Cam. 205-206, IASI J22/1230/2016 - RO36085083		ORANGE ROMANIA S.A. B-dul Lascar Catargiu, nr. 47-53, Europe House, sector 1, Bucuresti CUI: 9010105, J40/10178/1996		PROIECT NR.: 93 2021	
FORMAT PLANSA: 210 x 297mm				TITLU PROIECT: INSTALARE TRASEU FIBRA OPTICA SUBTERAN SI AERIAN (RETEA FTTH) PE STALPII DELGAZ GRID S.A. SI NOI PROIECTATI, IN COMUNA CORDUN, JUDETUL NEAMT	Faza: D.T.A.C. + P.TH.+D.E.
SPECIFICATIE	NUME	SEMNATURA	SCARA:	DENUMIRE PLANSA: DETALIU PRINDERE CABLU FIBRA OPTICA DE STALP	
SEF PROIECT	ING. PRISACARU ANDREI		1:20		
PROIECTAT	ING. ALUCULESEI C.		DATA:	PLANSA NR.: DSC1	
VERIFICAT	ING. CHIRILA IONUT		12.2021		
DESENAT	ARH. LORIN MARTINIUC				

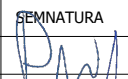





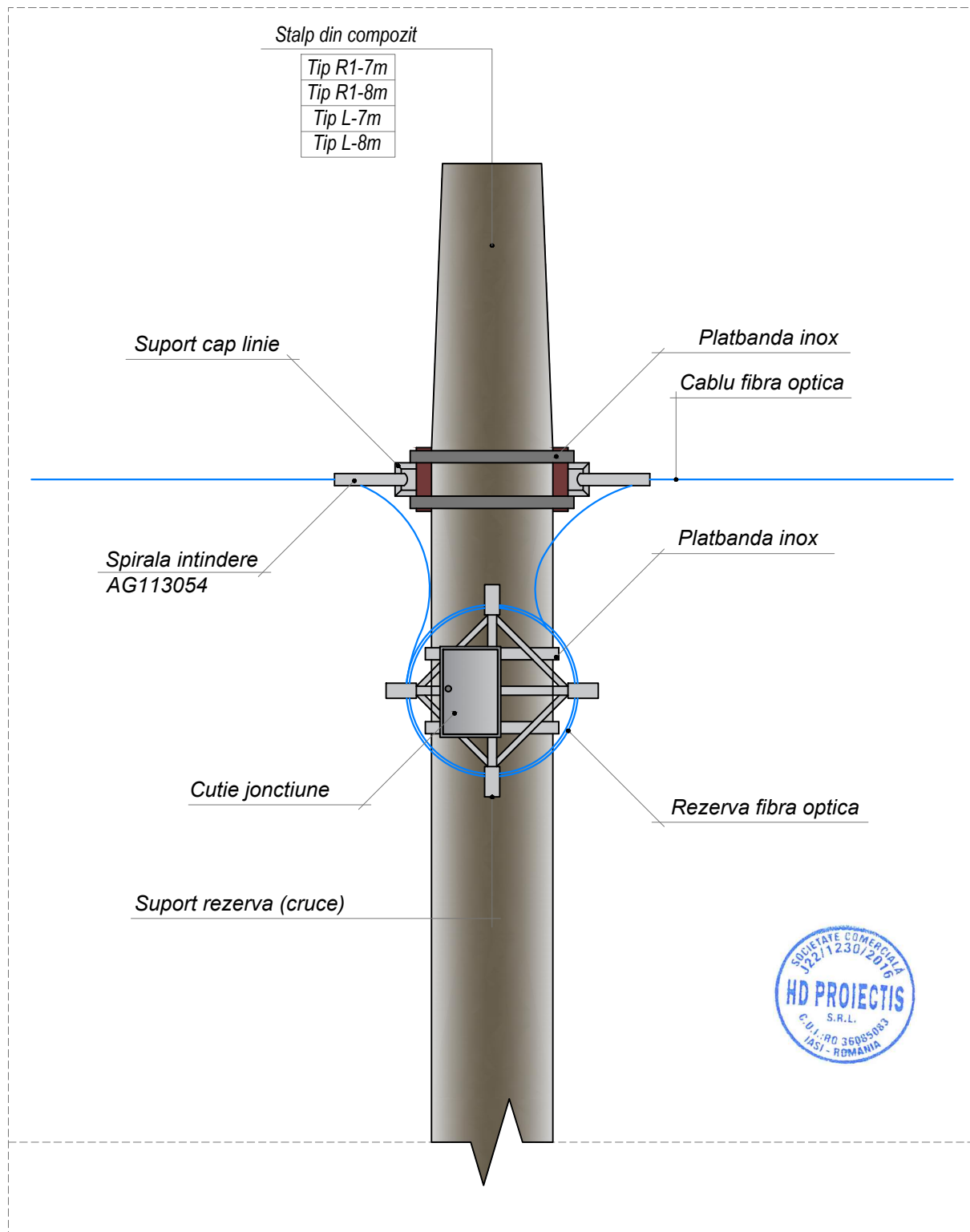

detaliu stalp din compozit cu rezerva de fibra optica

Verificator / Expert	NUME	SEMNATURA	CERINTA	REFERAT/EXPERTIZA NR./DATA	
NR. V.566	ING ROTARESCU A. IOAN		A1, A2		
 S.C. HD PROECTIS S.R.L. Sediul social: Bld. Carol I, Nr.4, Cladirea Habitat Proiect, Corp A, Etaj 2, Cam. 205-206, IASI J22/1230/2016 - RO36085083		 ORANGE ROMANIA S.A. B-dul Lascar Catargiu, nr. 47-53, Europe House, sector 1, Bucuresti CUI: 9010105, J40/10178/1996		PROIECT NR.: 93 2021	
FORMAT PLANSA: 210 x 297mm				TITLU PROIECT: INSTALARE TRASEU FIBRA OPTICA SUBTERAN SI AERIAN (RETEA FTTH) PE STALPII DELGAZ GRID S.A. SI NOI PROIECTATI, IN COMUNA CORDUN, JUDETUL NEAMT	Faza: D.T.A.C. + P.TH.+D.E.
SPECIFICATIE	NUME	SEMNATURA	SCARA:	DENUMIRE PLANSA: DETALIU STALP CU REZERVA DE FIBRA OPTICA PLANSA NR.: DSC2	
SEF PROIECT	ING. PRISACARU ANDREI		1:20		
PROIECTAT	ING. ALUCULESEI C.		DATA:		
VERIFICAT	ING. CHIRILA IONUT		12.2021		
DESENAT	ARH. LORIN MARTINIUC				

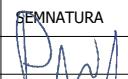

detaliu stalp din compozit cu rezerva de fibra optica si cutie de jonctiune

Verificator / Expert	NUME	SEMNATURA	CERINTA	REFERAT/EXPERTIZA NR./DATA	
NR. V.566	ING ROTARESCU A. IOAN		A1, A2		
 S.C. HD PROIECTIS S.R.L. Sediul social: Bld. Carol I, Nr.4, Cladirea Habitat Proiect, Corp A, Etaj 2, Cam. 205-206, IASI J22/1230/2016 - RO36085083		 ORANGE ROMANIA S.A. B-dul Lascar Catargiu, nr. 47-53, Europe House, sector 1, Bucuresti CUI: 9010105, J40/10178/1996		PROIECT NR.: 93 2021	
FORMAT PLANSA: 210 x 297mm				TITLU PROIECT: INSTALARE TRASEU FIBRA OPTICA SUBTERAN SI AERIAN (RETEA FTTH) PE STALPII DELGAZ GRID S.A. SI NOI PROIECTATI, IN COMUNA CORDUN, JUDETUL NEAMT	Faza: D.T.A.C. + P.TH.+D.E.
SPECIFICATIE	NUME	SEMNATURA	SCARA:	DENUMIRE PLANSA: DETALIU STALP CU REZERVA DE FIBRA OPTICA SI CUTIE JONCTIUNI	
SEF PROIECT	ING. PRISACARU ANDREI		1:20		
PROIECTAT	ING. ALUCULESEI C.		DATA:		
VERIFICAT	ING. CHIRILA IONUT		12.2021		
DESENAT	ARH. LORIN MARTINIUC				
				PLANSA NR.: DSC3	

Pamant compactat

PLAN

Stalp din compozit

Tip R1-7m
Tip R1-8m
Tip L-7m
Tip L-8m

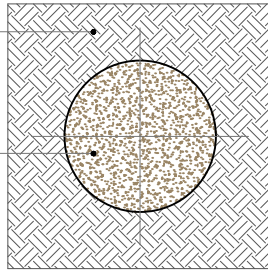

Incastarea stalpilor consta in fixarea stalpilor in gropi si umplerea acestora cu pamant nevegetal bine compactat.

Operatiunile principale la executarea incastrii sunt urmatoarele:

- Trasarea gropilor;
- Saparea gropilor;
- Incastrarea stalpilor;
- Compactarea stratului de pamant nevegetal;
- Executia unei caciulii de pamant de minim 20 cm inaltime de la baza stalpului.

SECTIUNE



Stalp din compozit

Tip R1-7m
Tip R1-8m
Tip L-7m
Tip L-8m

Caciulie de pamant

Strat pamant nevegetal compactat

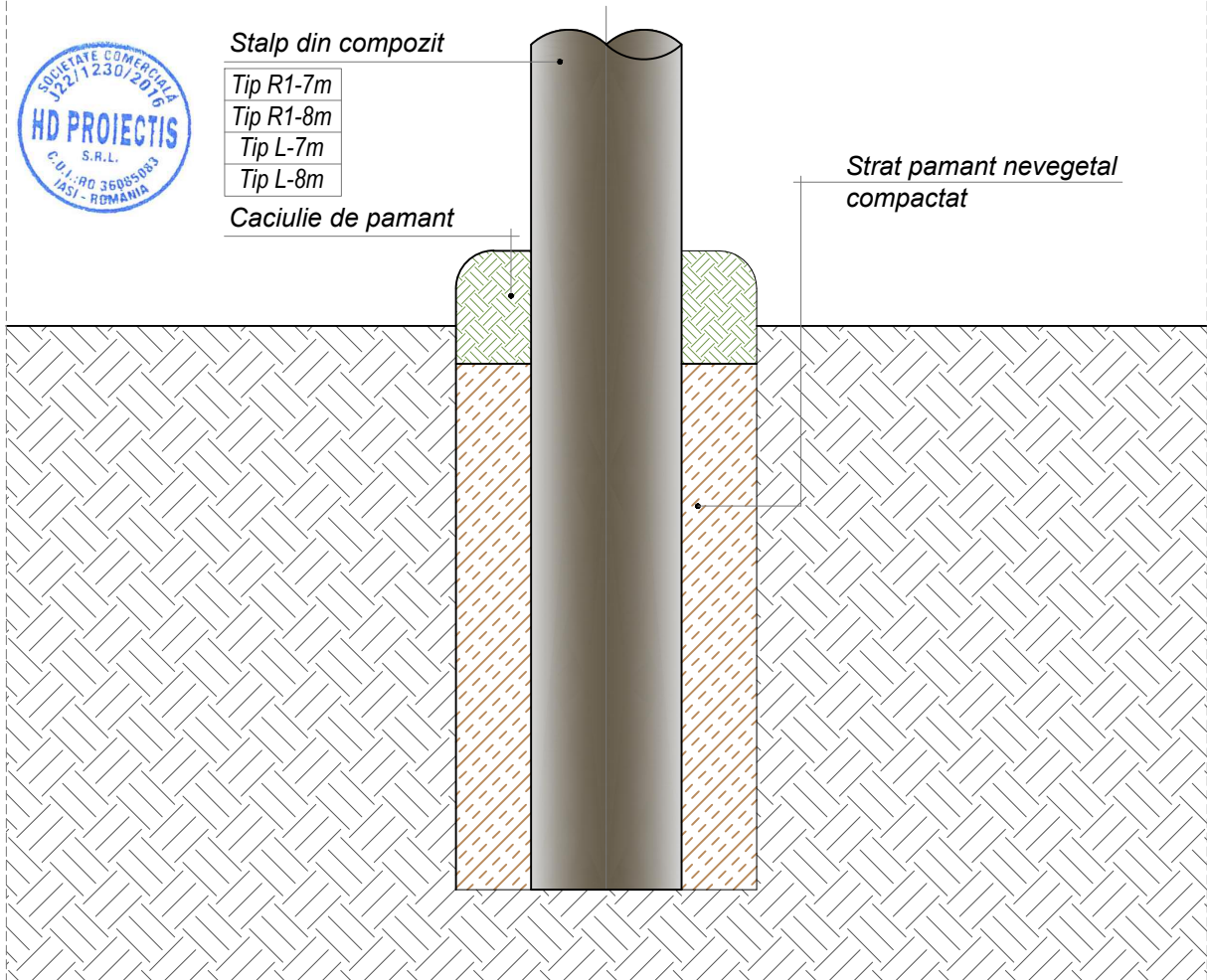



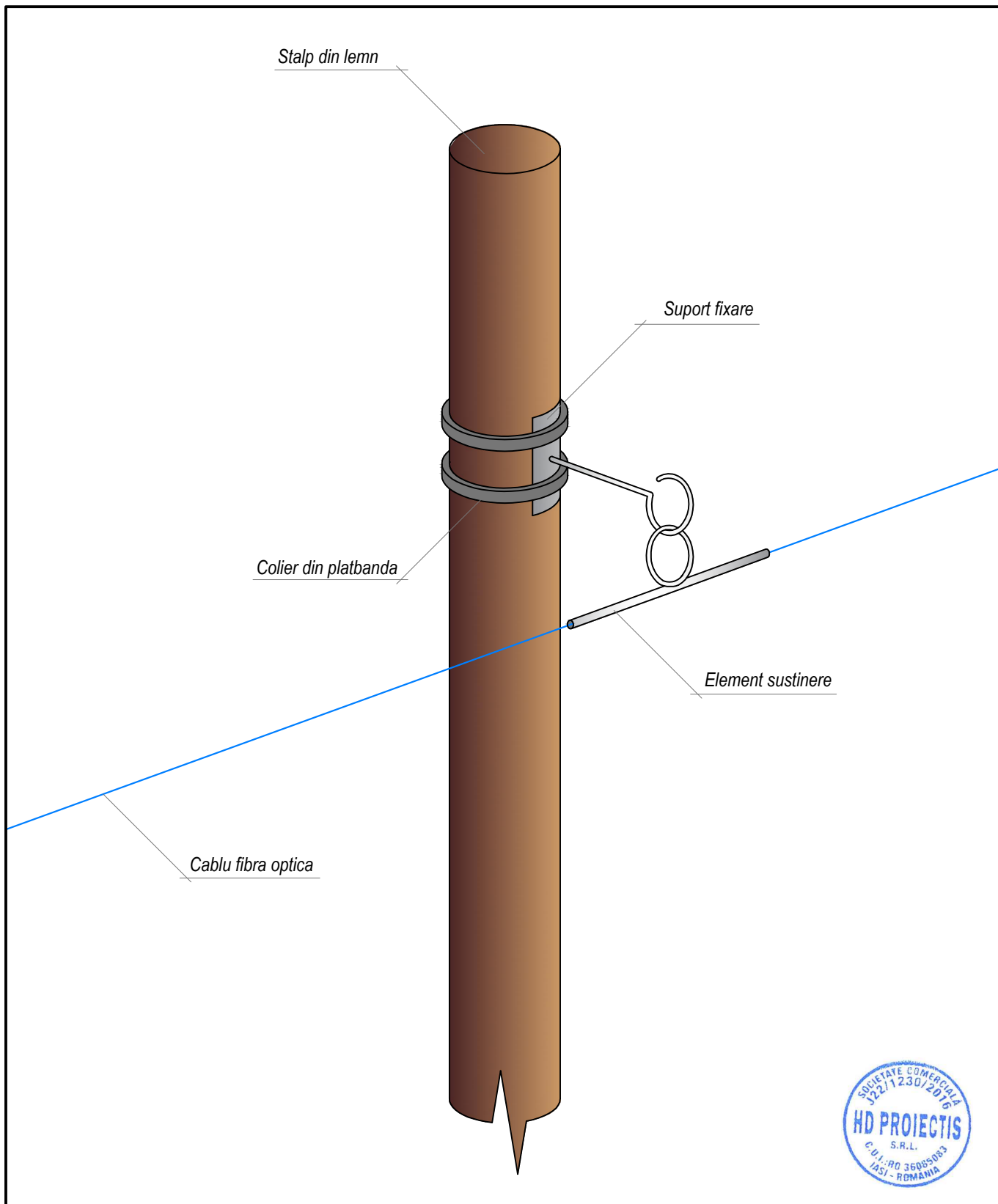

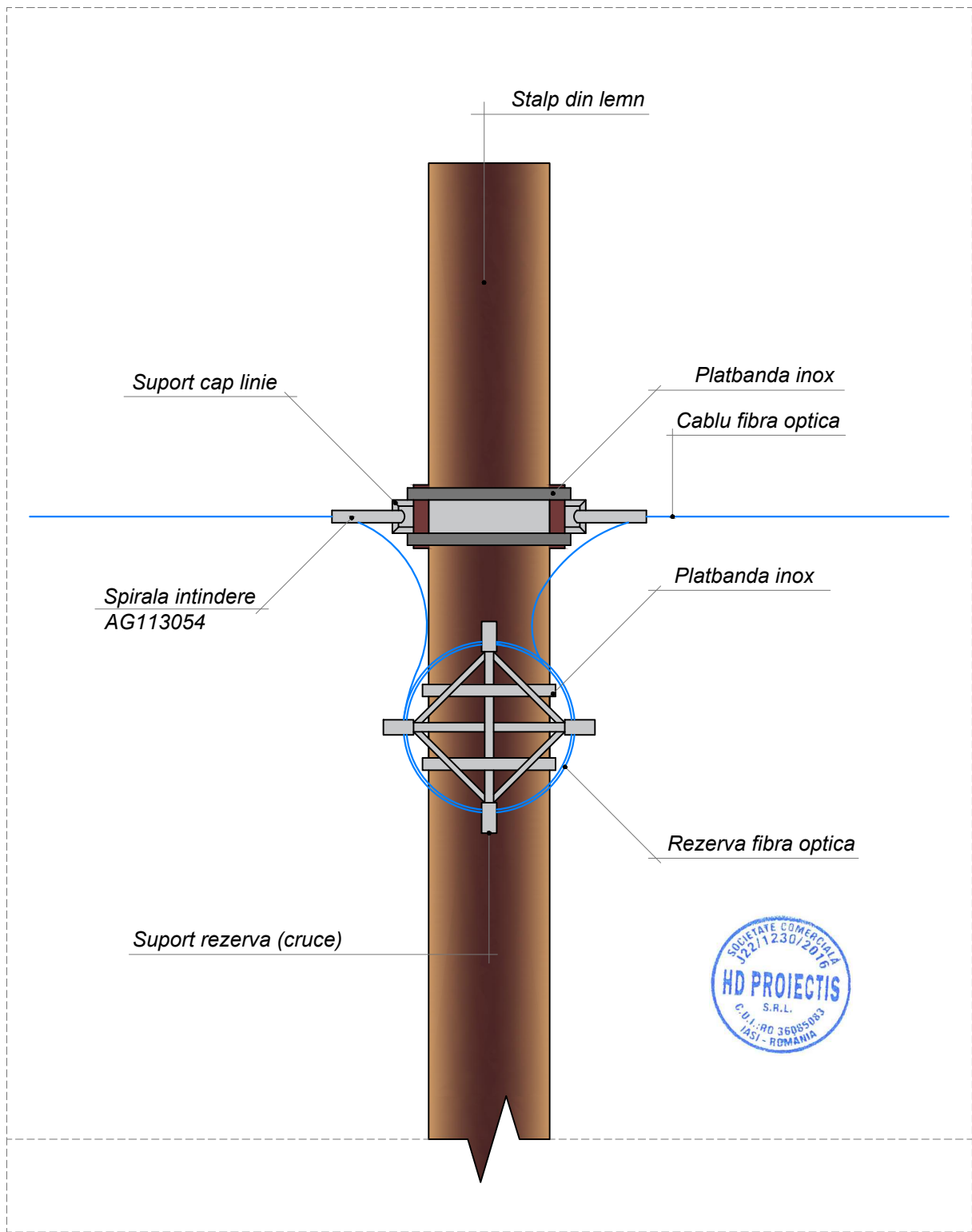

Verificator / Expert	NUME	SEMNTATURA	CERINTA	REFERAT/EXPERTIZA NR./DATA
NR. V.566	ING ROTARESCU A. IOAN		A1, A2	
PROIECTANT:	S.C. HD PROIECTIS S.R.L. Sediul social: Bld. Carol I, Nr.4, Cladirea Habitat Proiect, Corp A, Etaj 2, Cam. 205-206, IASI J22/1230/2016 - RO36085083			PROIECT NR.: 93 2021
FORMAT PLANSA: 210 x 297mm				TITLU PROIECT: INSTALARE TRASEU FIBRA OPTICA SUBTERAN SI AERIAN (RETEA FTTH) PE STALPII DELGAZ GRID S.A. SI NOI PROIECTATI, IN COMUNA CORDUN, JUDETUL NEAMT
SPECIFICATIE	NUME	SEMNTATURA	SCARA:	Faza: D.T.A.C. + P.TH.+D.E.
SEF PROIECT	ING. PRISACARU ANDREI		1:20	
PROIECTAT	ING. ALUCULESEI C.		DATA:	DENUMIRE PLANSA:
VERIFICAT	ING. CHIRILA IONUT		12.2021	DETAIU PLANTARE STALP DIN COMPOZIT, IN FUNDATIE BURATA
DESENAT	ARH. LORIN MARTINIUC			PLANSA NR.: DSC4



Verificator / Expert	NUME	SEMNATURA	CERINTA	REFERAT/EXPERTIZA NR./DATA
NR. V.566	ING ROTARESCU A. IOAN		A1, A2	
S.C. HD PROIECTIS S.R.L. Sediu social: Bld. Carol I, Nr.4, Cladirea Habitat Proiect, Corp A, Etaj 2, Cam. 205-206, IASI J22/1230/2016 - RO36085083		ORANGE ROMANIA S.A. B-dul Lascar Catargiu, nr. 47-53, Europe House, sector 1, Bucuresti CUI: 9010105, J40/10178/1996		PROIECT NR.: 93 2021
FORMAT PLANSA: 210 x 297mm			TITLU PROIECT: INSTALARE TRASEU FIBRA OPTICA SUBTERAN SI AERIAN (RETEA FTTH) PE STALPII DELGAZ GRID S.A. SI NOI PROIECTATI, IN COMUNA CORDUN, JUDETUL NEAMT	
SPECIFICATIE	NUME	SEMNATURA	SCARA:	Faza: D.T.A.C. + P.TH.+D.E.
SEF PROIECT	ING. PRISACARU ANDREI		1:20	
PROIECTAT	ING. ALUCULESEI C.		DATA:	
VERIFICAT	ING. CHIRILA IONUT		12.2021	
DESENAT	ARH. LORIN MARTINIUC			DENUMIRE PLANSA: DETALIU PRINDERE CABLU FIBRA OPTICA DE STALP PLANSA NR.: DSL1

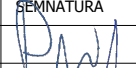

detaliu stalp din lemn cu rezerva de fibra optica

Verificator / Expert	NUME	SEMNATURA	CERINTA	REFERAT/EXPERTIZA NR./DATA	
NR. V.566	ING ROTARESCU A. IOAN		A1, A2		
 S.C. HD PROIECTIS S.R.L. Sediu social: Bld. Carol I, Nr.4, Cladirea Habitat Proiect, Corp A, Etaj 2, Cam. 205-206, IASI J22/1230/2016 - RO36085083		 ORANGE ROMANIA S.A. B-dul Lascar Catargiu, nr. 47-53, Europe House, sector 1, Bucuresti CUI: 9010105, J40/10178/1996		PROIECT NR.: 93 2021	
FORMAT PLANSA: 210 x 297mm				TITLU PROIECT: INSTALARE TRASEU FIBRA OPTICA SUBTERAN SI AERIAN (RETEA FTTH) PE STALPII DELGAZ GRID S.A. SI NOI PROIECTATI, IN COMUNA CORDUN, JUDETUL NEAMT	Faza: D.T.A.C. + P.TH.+D.E.
SPECIFICATIE	NUME	SEMNATURA	SCARA:	DENUMIRE PLANSA: DETALIU STALP CU REZERVA DE FIBRA OPTICA PLANSA NR.: DSL2	
SEF PROIECT	ING. PRISACARU ANDREI		1:20		
PROIECTAT	ING. ALUCULESEI C.		DATA:		
VERIFICAT	ING. CHIRILA IONUT		12.2021		
DESENAT	ARH. LORIN MARTINIUC				

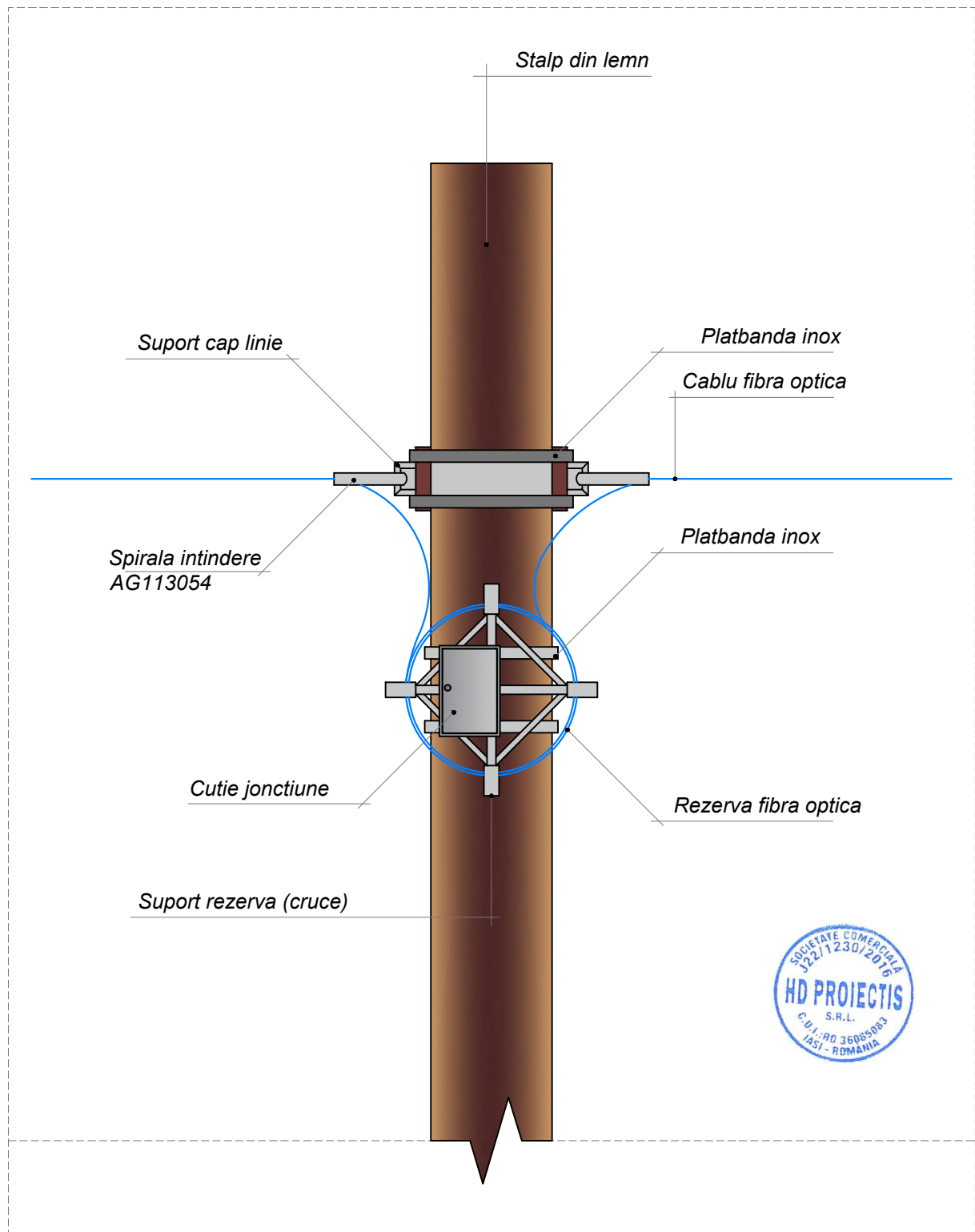

detaliu stalp din lemn cu rezerva de fibra optica si cutie de jonctiune

Verificator / Expert	NUME	SEMNATURA	CERINTA	REFERAT/EXPERTIZA NR./DATA	
NR. V.566	ING ROTARESCU A. IOAN		A1, A2		
S.C. HD PROIECTIS S.R.L. Sediu social: Bld. Carol I, Nr.4, Cladirea Habitat Proiect, Corp A, Etaj 2, Cam. 205-206, IASI J22/1230/2016 - RO36085083		ORANGE ROMANIA S.A. B-dul Lascar Catargiu, nr. 47-53, Europe House, sector 1, Bucuresti CUI: 9010105, J40/10178/1996		PROIECT NR.: 93 2021	
FORMAT PLANSA: 210 x 297mm				TITLU PROIECT: INSTALARE TRASEU FIBRA OPTICA SUBTERAN SI AERIAN (RETEA FTTH) PE STALPII DELGAZ GRID S.A. SI NOI PROIECTATI, IN COMUNA CORDUN, JUDETUL NEAMT	Faza: D.T.A.C. + P.TH.+D.E.
SPECIFICATIE	NUME	SEMNATURA	SCARA:	DENUMIRE PLANSA: DETALIU STALP CU REZERVA DE FIBRA OPTICA SI CUTIE JONCTIUNI	
SEF PROIECT	ING. PRISACARU ANDREI		1:20		
PROIECTAT	ING. ALUCULESEI C.		DATA:		
VERIFICAT	ING. CHIRILA IONUT		12.2021		
DESENAT	ARH. LORIN MARTINIUC				
				PLANSA NR.: DSL3	